

Catalogue

MEDICAL PRODUCTION

2024

| | | |
|------------|------------------------------|---|
| MED | disposable supplies |  |
| LAB | laboratory aids |  |
| VET | veterinary technical devices |  |

CONTENT:

MED medical devices

| | |
|--------------------------------|--------------|
| Infusion sets and equipment | page 3 - 30 |
| Transfusion sets | page 31 - 33 |
| Plastic extension tubes | page 34 - 53 |
| Transfer sets | page 54 - 56 |
| Accessories for dialysis | page 57 |
| Urinal aids and accessories | page 58 - 68 |
| Catheters | page 69 - 75 |
| Nasal aspirators | page 76 - 79 |
| PVC tubes for medical purposes | page 80 - 81 |

LAB laboratory aids

| | |
|---------------------------------|----------------|
| Petri dishes | page 82 - 88 |
| Test tubes | page 89 - 97 |
| Microtitration plates and other | page 98 - 106 |
| Pasteur pipettes | page 107 - 150 |

VET veterinary technical devices

| | |
|-------------------------|----------------|
| HEMOS taking sets | page 151 - 153 |
| Sampling kits and other | page 154 - 157 |

OEM, custom production and service

Explanatory notes

Contacts

MED medical devices

Infusion sets and equipment

Infusion sets for gravity feed

Infusion sets are used to deliver infusion solutions from bottles or plastic bags into a patient's vein by gravity. They're individually sterile packed and designed for single use only.

Infusion set IS-101

| | |
|----------------------|-----------------------------------|
| Product No.: | V606101-ND |
| Name (abbreviation): | Infusion set IS-101 |
| Version: | Sterile-EO |
| Group packaging: | - |
| Shipping packaging: | 200 pcs/carton 3.600 pcs/pallet |



Description:

- the infusion set meets the requirements of the ČSN EN ISO 8536-4 standard
- DEHP-free
- piercing spike protected by a cover
- transparent drip chamber for observing of falling a drops
- drip tube for even droplet formation (20 drops = 1 ± 0.1 ml)
- air supply means (aerator) equipped with an air, hydrophobic filter against the intrusion of microorganisms (filter porosity 3.0 mm)
- PVC hose made of flexible material, transparent so that the passage of air bubbles can be observed
- hose size 3.0 / 4.2 mm, length 150 cm
- infusion filter 15 mm
- flow regulator for flow adjustment in the range from zero to maximum, it's equipped with a hose holder
- connection end without Male Luer thread

Single use medical device intended for therapeutic administration of infusion solutions from bottles or plastic bags by gravitation effect.

Infusion set IS-102

| | |
|----------------------|-----------------------------------|
| Product No.: | V606102-ND |
| Name (abbreviation): | Infusion set IS-102 |
| Version: | Sterile-EO |
| Group packaging: | - |
| Shipping packaging: | 200 pcs/carton 3.600 pcs/pallet |

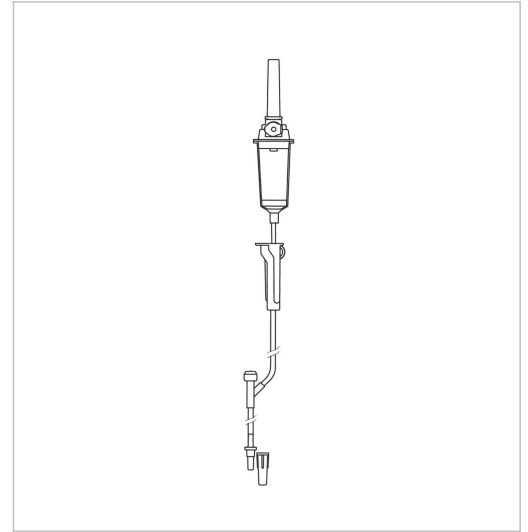

Description:

- the infusion set meets the requirements of the ČSN EN ISO 8536-4 standard
- DEHP-free
- piercing spike protected by a cover
- transparent drip chamber for observing of falling a drops
- drip tube for even droplet formation (20 drops = 1 ± 0.1 ml)
- air supply device equipped with an air-hydrophobic filter against the intrusion of microorganisms (filter porosity 3.0 mm)
- PVC hose made of flexible material, transparent so that the passage of air bubbles can be observed
- hose size 3.0 / 4.2 mm, length 160 cm
- infusion filter 15 mm
- flow regulator for flow adjustment in the range from zero to maximum, it's equipped with a hose holder
- injection part for immediate repeatable injection of medicines with a needle
- connection end without Male Luer thread

Single use medical device intended for therapeutic administration of infusion solutions from bottles or plastic bags by gravitation effect.

Infusion set IS-103

| | |
|----------------------|-----------------------------------|
| Product No.: | V606103-ND |
| Name (abbreviation): | Infusion set IS-103 |
| Version: | Sterile-EO |
| Group packaging: | - |
| Shipping packaging: | 200 pcs/carton 3.600 pcs/pallet |

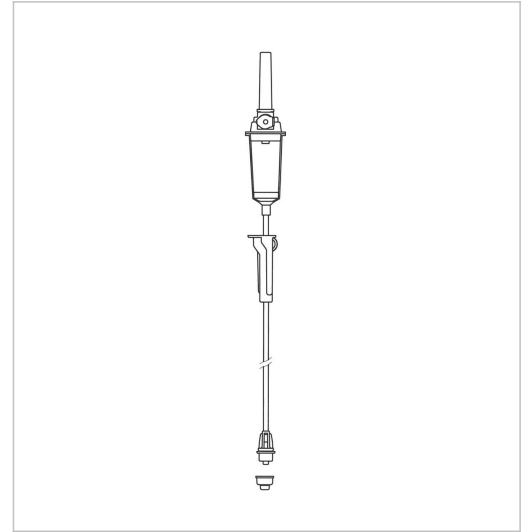

Description:

- the infusion set meets the requirements of the ČSN EN ISO 8536-4 standard
- DEHP-free
- piercing spike protected by a cover
- transparent drip chamber for observing of falling a drops
- drip tube for even droplet formation (20 drops = 1 ± 0.1 ml)
- air supply means (aerator) equipped with an air, hydrophobic filter against the intrusion of microorganisms (filter porosity 3.0 mm)
- PVC hose made of flexible material, transparent so that the passage of air bubbles can be observed
- hose size 3.0 / 4.2 mm, length 150 cm
- infusion filter 15 mm
- flow regulator for flow adjustment in the range from zero to maximum, it's equipped with a hose holder
- connection end with Male Luer Lock thread

Single use medical device intended for therapeutic administration of infusion solutions from bottles or plastic bags by gravitation effect.

IS-103-bal. 4x50 pcs

| | |
|----------------------|-----------------------------------|
| Product No.: | V606103-01ND |
| Name (abbreviation): | IS-103-bal. 4x50 pcs |
| Version: | Sterile-EO |
| Group packaging: | 4 pack x 50 pcs |
| Shipping packaging: | 200 pcs/carton 3.600 pcs/pallet |



Description:

- the infusion set meets the requirements of the ČSN EN ISO 8536-4 standard
- DEHP-free
- piercing spike protected by a cover
- transparent drip chamber for observing of falling a drops
- drip tube for even droplet formation (20 drops = 1 ± 0.1 ml)
- air supply means (aerator) equipped with an air, hydrophobic filter against the intrusion of microorganisms (filter porosity 3.0 mm)
- PVC hose made of flexible material, transparent so that the passage of air bubbles can be observed
- hose size 3.0 / 4.2 mm, length 150 cm
- infusion filter 15 mm
- flow regulator for flow adjustment in the range from zero to maximum, it's equipped with a hose holder
- connection end with Male Luer Lock thread

Single use medical device intended for therapeutic administration of infusion solutions from bottles or plastic bags by gravitation effect.

Infusion sets for overpressure infusion for pumps Ivac Star-flow

It's used for therapeutic administration of infusion solutions from bottles or bags using infusion pumps IVAC Star-flow.

Infusion set IS-121

| | |
|----------------------|-----------------------------------|
| Product No.: | V606121 |
| Name (abbreviation): | Infusion set IS-121 |
| Version: | Sterile-EO |
| Group packaging: | - |
| Shipping packaging: | 150 pcs/carton 2.700 pcs/pallet |

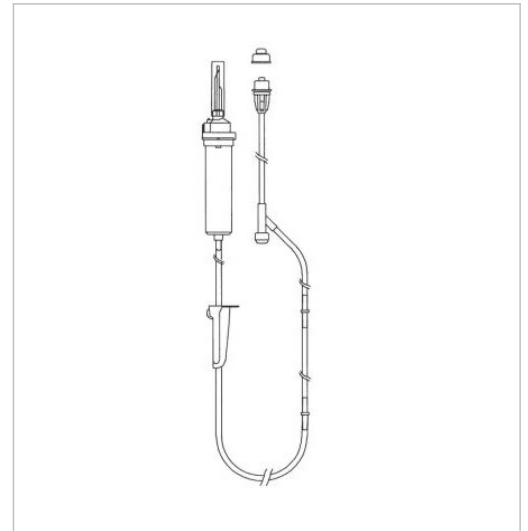

Description:

- IS-121 meets the requirements of the ČSN EN ISO 8536-8 standard
- The pump segment hose contains DEHP
- piercing spike, dimensions according to ČSN EN ISO 8536-4
- transparent drip chamber with holder for mounting in the optical drop sensor
- drip tube for even droplet formation (20 drops = 1 ± 0.1 ml)
- 15 mm infusion filter to capture solid particles
- air supply mean (aerator) equipped with a hydrophobic bacterial filter to prevent the penetration of microorganisms with a porosity of 1.2 mm
- pump segment PVC hose 2.7/3.9 mm, length 195 mm
- PVC connecting hose made of flexible, transparent material, size 3.0/4.2 mm
- flow regulator setting in the range from zero to maximum
- connection end with Male Luer Lock thread
- injection part for immediate repeatable injection of medicines with a needle
- safe and easily removable cover piercing spike and connection cone cover to maintain sterility

Single use medical device intended for therapeutic administration of infusion solutions from bottles or bags by using infusion pumps. Each set type is designed for a specific pump type:
 The set IS-121 - infusion pump Star-flow 581.

Infusion set IS-123

| | |
|----------------------|-----------------------------------|
| Product No.: | V606123 |
| Name (abbreviation): | Infusion set IS-123 |
| Version: | Sterile-EO |
| Group packaging: | - |
| Shipping packaging: | 150 pcs/carton 2.700 pcs/pallet |

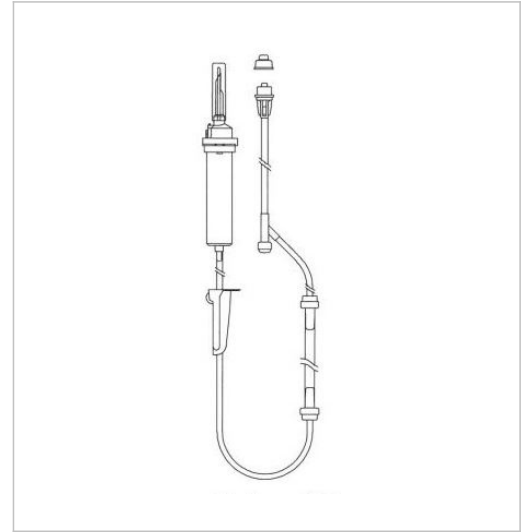

Description:

- IS-123 meets the requirements of the ČSN EN ISO 8536-8 standard
- DEHP-free
- piercing spike, dimensions according to ČSN EN ISO 8536-4
- transparent drip chamber with holder for mounting in the optical drop sensor
- drip tube for even droplet formation (20 drops = 1 ± 0.1 ml)
- 15 mm infusion filter to capture solid particles
- air supply mean (aerator) equipped with a hydrophobic bacterial filter to prevent the penetration of microorganisms with a porosity of 1.2 mm
- pump segment silicone hose 3.35/5.17 mm, length 124 mm
- PVC connecting hose made of flexible, transparent material, size 3.0/4.2 mm
- flow regulator setting in the range from zero to maximum
- connection end with Male Luer Lock thread
- injection part for immediate repeatable injection of medicines with a needle
- safe and easily removable cover piercing spike and connection cone cover to maintain sterility

Single use medical device intended for therapeutic administration of infusion solutions from bottles or bags by using infusion pumps. Each set type is designed for a specific pump type:
 The set IS-123 - infusion pump Star-flow 591.

Infusions sets for gravity or overpressure infusion

They are used for therapeutic administration of infusion solutions from bottles (bags) by gravity or using infusion pumps INFUSOMAT P, ARGUS 707, A400, A404, A414, VOLUMED μ VP5005 . The products have a drop chamber with a ring for fitting in optical drop sensor, 15 μ m infusion filter, vented spike with hydrophobic bacterial filter, flow controller (clamp with wheel), transparent PVC tube 3.0/4.1 mm and positive connection cone Male Luer Lock.

Infusion set IS-127 P

| | |
|----------------------|-----------------------------------|
| Product No.: | V606127-ND |
| Name (abbreviation): | Infusion set IS-127 P |
| Version: | Sterile-EO |
| Group packaging: | 4 pack x 50 pcs |
| Shipping packaging: | 200 pcs/carton 3.600 pcs/pallet |



Description:

- this set meets the requirements of the ČSN EN ISO 8536-8 standard
- piercing spike transparent, dimensions according to ČSN EN ISO 8536-4
- transparent PVC DEHP-free drip chamber with max. line for liquid level adjustment and with collar for mounting in the optical drop sensor
- drip tube for even droplet formation (20 drops = 1 ± 0.1 ml)
- air supply means (aerator) equipped with an air hydrophobic filter against the intrusion of microorganisms (filter porosity 3.0 mm)
- PVC hose made of flexible and strong material resistant to strain in the infusion pump
- hose size 3.0/4.1 mm, length 150 cm
- 15 mm infusion filter to capture solid particles
- flow regulator with holder for fixing the end of the set (solves "Spaghetti syndrome"), flow setting in the range from zero to maximum
- connection end with Male Luer Lock thread
- safe and easily removable piercing spike and connection cone cover to maintain sterility.

Note:

It must not be used: for infusing medicines that are incompatible with PVC (cytostatics) and for infusing light-sensitive medicines.

Benefits for users:

- DEHP-free and LATEX-free materials used for production
- pressure resistance up to 2 bar
- universal use for gravity and overpressure infusion
- production automation guaranteeing constant and high production quality

Infusion set IS-127 P is a single use medical device designed for therapeutic administration of infusion solutions from bottles (bags) by gravity or infusion pumps: INFUSOMAT P - manufacturer B / Braun
ARGUS A400, A404, A414, 707 - manufacturer Argus.

Infusion set IS-127 P 180 cm

| | |
|----------------------|-----------------------------------|
| Product No.: | V606128-ND |
| Name (abbreviation): | Infusion set IS-127 P 180 cm |
| Version: | Sterile-EO |
| Group packaging: | 4 pack x 50 pcs |
| Shipping packaging: | 200 pcs/carton 3.600 pcs/pallet |



Description:

- this set meets the requirements of the ČSN EN ISO 8536-8 standard
- piercing spike transparent, dimensions according to ČSN EN ISO 8536-4
- transparent PVC DEHP-free drip chamber with max. Line for liquid level adjustment and with collar for mounting in the optical drop sensor
- drip tube for even droplet formation (20 drops = 1 ± 0.1 ml)
- air supply means (aerator) equipped with an air hydrophobic filter against the intrusion of microorganisms (filter porosity 3.0 mm)
- PVC hose made of flexible and strong material resistant to strain in the infusion pump
- hose size 3.0/4.1 mm, length 180 cm
- 15 mm infusion filter to capture solid particles
- flow regulator with holder for fixing the end of the set (solves "Spaghetti syndrome"), flow setting in the range from zero to maximum
- connection end with Male Luer Lock thread
- safe and easily removable piercing spike and connection cone cover to maintain sterility

Note:

It must not be used: for infusing medicines that are incompatible with PVC (cytostatics) and for infusing light-sensitive medicines.

Benefits for users:

- DEHP-free and LATEX-free materials used for production
- pressure resistance up to 2 bar
- universal use for gravity and overpressure infusion
- production automation guaranteeing constant and high production quality

Infusion set IS-127 P is a single use medical device designed for therapeutic administration of infusion solutions from bottles (bags) by gravity or infusion pumps: INFUSOMAT P - manufacturer B / Braun
 ARGUS A400, A404, A414, 707 - manufacturer Argus.

Venous pressure meters

Venous pressure meters are intended for the approximate determination of the patient's central venous pressure (CVP). The value of the patient's central venous pressure indirectly informs about the level of hydration and the size of the venous return and is therefore only indicative. This is not a treatment procedure but a way of monitoring the trend of CVP. The scale on the manometric branch is only indicative and is not used as a gauge, it only serves to determine the approximate value of CVP. A central venous catheter is used to accurately measure the CVP value.

MŽT-01

| | |
|----------------------|---------------------------------|
| Product No.: | V646992-ND |
| Name (abbreviation): | MŽT-01 |
| Version: | Sterile-EO |
| Group packaging: | - |
| Shipping packaging: | 40 pcs/carton 2400 pcs/pallet |



Description:

- the kit meets the requirements of the ČSN EN ISO 8536-4 standard
- DEHP-free
- three-way tap for setting the required flow direction
- PVC connecting hose 3.0/4.2 mm, length 600 mm
- manometric branch with a scale for reading venous pressure, i.e. PVC hose 3.6/4.8 mm, length 620 mm
- connection end without Male Luer thread
- safe and easily removable cover for connection cone and three-way tap to maintain sterility

Single use medical device intended to orientatively determine the patient's central venous pressure (CVP). The value of the patient's central venous pressure indirectly informs about the level of hydration and the size of venous return and is therefore only indicative. This is not a treatment procedure but a way of monitoring the trend of CVP. The scale on the manometric branch is only indicative and is not used as a gauge it only serves to determine the approximate value of CVP. A central venous catheter is used for accurate measurement of the CVP value.

MŽT-01 MLL

| | |
|----------------------|---------------------------------|
| Product No.: | V646992-01ND |
| Name (abbreviation): | MŽT-01 MLL |
| Version: | Sterile-EO |
| Group packaging: | - |
| Shipping packaging: | 40 pcs/carton 2400 pcs/pallet |



Description:

- the kit meets the requirements of the ČSN EN ISO 8536-4 standard
- DEHP-free
- three-way tap for setting the required flow direction
- PVC connecting hose 3.0/4.2 mm, length 600 mm
- manometric branch with a scale for reading venous pressure, i.e. PVC hose 3.6/4.8 mm, length 620 mm
- connection end with Male Luer Lock thread
- safe and easily removable cover for connection cone and three-way tap to maintain sterility

Single use medical device intended to orientatively determine the patient's central venous pressure (CVP). The value of the patient's central venous pressure indirectly informs about the level of hydration and the size of venous return and is therefore only indicative. This is not a treatment procedure, but a way of monitoring the trend of CVP. The scale on the manometric branch is only indicative and is not used as a gauge it only serves to determine the approximate value of CVP. A central venous catheter is used for accurate measurement of the CVP value.

MŽT-02

| | |
|----------------------|---------------------------------|
| Product No.: | V646993-ND |
| Name (abbreviation): | MŽT-02 |
| Version: | Sterile-EO |
| Group packaging: | - |
| Shipping packaging: | 40 pcs/carton 2400 pcs/pallet |

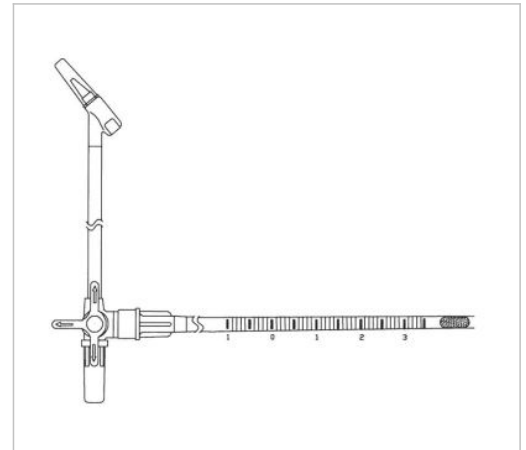

Description:

- the kit meets the requirements of the ČSN EN ISO 8536-4 standard
- DEHP-free
- three-way tap for setting the required flow direction
- PVC connecting hose 3.0/4.2 mm, length 600 mm
- manometric branch with a scale for reading venous pressure, i.e. PVC hose 3.6/4.8 mm, length 620 mm
- Male Luer unthreaded connection end with injection part
- safe and easily removable cover for connection cone and three-way tap to maintain sterility

Single use medical device intended to orientatively determine the patient's central venous pressure (CVP). The value of the patient's central venous pressure indirectly informs about the level of hydration and the size of venous return and is therefore only indicative. This is not a treatment procedure, but a way of monitoring the trend of CVP. The scale on the manometric branch is only indicative and is not used as a gauge it only serves to determine the approximate value of CVP. A central venous catheter is used for accurate measurement of the CVP value.

Needles ports

The needleless port is a closed, safety system ensuring microbiological safety, which is designed for repeated application and aspiration from intravenous accessories (syringes, infusion sets, cannulas, taps, catheters, extension tubes) with Luer termination when performing infusion therapy, injection therapy, sampling, chemotherapy and can also be used in magnetic resonance imaging. The color resolution of the needle-free inputs in red and blue makes it easier to identify an arterial or venous line.

The needleless inlet must always be replaced after a maximum of 7 days or after 100 connections.

Needles port - red

| | |
|----------------------|------------------------------------|
| Product No.: | V696421 |
| Name (abbreviation): | Needles port - red |
| Version: | Sterile-EO |
| Group packaging: | 10 pack x 50 pcs |
| Shipping packaging: | 500 pcs/carton 12 000 pcs/pallet |

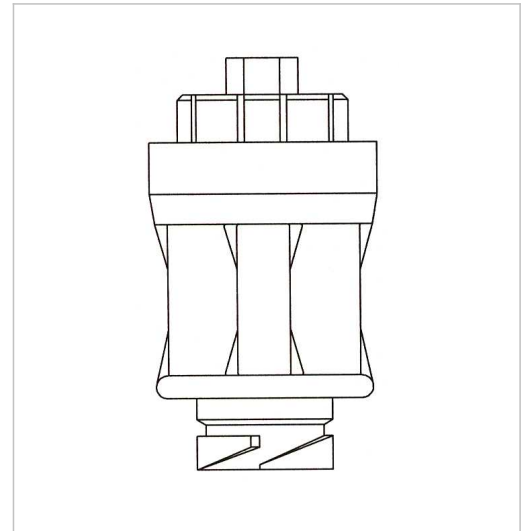

Description:

- BPA-free silicone and polycarbonate material are used for production = Bisphenol A
- transparent material allows flow and flush monitoring
- no internal moving parts or mechanisms that increase the risk of contamination
- compatible with Luer Slip and Luer Lock
- can also be used for lipid solutions
- allows multiple access for direct aspiration or fluid application
- usage time max. 7 days or 100 connections
- smooth surface for easy disinfection
- can be disinfected according to national or hospital guidelines and is alcohol resistant
- is suitable for high pressure applications up to 2 bars
- can be used for all patients for whom infusion therapy is prescribed, no gender or age restrictions, can be used for adults, paediatricians and new-borns
- residual volume: 0.09 ml
- straight and direct inner shape maximizes flow:
 - 1 psi: 550 ml/min = gravitational flow
 - 3 psi: 1000 ml/min
 - 5 psi: 1300 ml/min

Risk prevention:

- provides secure needle-free access
- prevents bloodstream infections
- closed system helps reduce the risk of air embolism thanks to a self-sealing valve that prevents air from being sucked in
- not made of PVC, DEHP or latex

The needleless port is a closed, safety system ensuring microbiological safety which is designed for repeated application and aspiration from intravenous accessories (syringes, infusion sets, cannulas, taps, catheters, extension tubes) with Luer termination when performing infusion therapy, injection therapy, sampling, chemotherapy and can also be used in magnetic resonance imaging. The color resolution of the needle-free inputs in red and blue makes it easier to identify an arterial or venous line. The needleless inlet must always be replaced after a maximum of 7 days or after 100 connections.

Needles port

| | |
|----------------------|------------------------------------|
| Product No.: | V696420 |
| Name (abbreviation): | Needles port |
| Version: | Sterile-EO |
| Group packaging: | 10 pack x 50 pcs |
| Shipping packaging: | 500 pcs/carton 12.000 pcs/pallet |



Description:

- BPA-free silicone and polycarbonate material are used for production = Bisphenol A
- transparent material allows flow and flush monitoring
- no internal moving parts or mechanisms that increase the risk of contamination
- compatible with Luer Slip and Luer Lock
- can also be used for lipid solutions
- allows multiple access for direct aspiration or fluid application
- usage time max. 7 days or 100 connections
- smooth surface for easy disinfection
- can be disinfected according to national or hospital guidelines and is alcohol resistant
- is suitable for high pressure applications up to 2 bars
- can be used for all patients for whom infusion therapy is prescribed, no gender or age restrictions, can be used for adults, paediatricians and new-borns
- residual volume: 0.09 ml
- straight and direct inner shape maximizes flow:
 - 1 psi: 550 ml/min = gravitational flow
 - 3 psi: 1000 ml/min
 - 5 psi: 1300 ml/min

Risk prevention:

- provides secure needle-free access
- prevents bloodstream infections
- closed system helps reduce the risk of air embolism thanks to a self-sealing valve that prevents air from being sucked in
- not made of PVC, DEHP or latex

The needleless port is a closed, safety system ensuring microbiological safety which is designed for repeated application and aspiration from intravenous accessories (syringes, infusion sets, cannulas, taps, catheters, extension tubes) with Luer termination when performing infusion therapy, injection therapy, sampling, chemotherapy and can also be used in magnetic resonance imaging. The color resolution of the needle-free inputs in red and blue makes it easier to identify an arterial or venous line. The needleless inlet must always be replaced after a maximum of 7 days or after 100 connections.

Three way taps, ramps

Taps, ramps are intended for concurrent infusion therapies when administering infusions or medicaments. They allow setup, control or termination of required fluid flow direction. They're intended for pressure as well as gravity applications up to 2 bar pressure for up to the maximum 72 hours for three-way taps or 1.5 bar for a maximum 72 hours for ramps. Can also be used for lipid solutions.

Three-way tap-red NO PVC

| | |
|----------------------|------------------------------------|
| Product No.: | V696434 |
| Name (abbreviation): | Three-way tap-red NO PVC |
| Version: | Sterile-EO |
| Group packaging: | 10 pack x 50 pcs |
| Shipping packaging: | 500 pcs/carton 12.000 pcs/pallet |



Description:

- lipid resistance
- one Male Luer Lock connection end with swivel nut and two Female Luer Lock ends
- All connection ends are protected by covers to maintain sterility
- red colour to indicate the arterial line
- transparent material allows flow and flush monitoring
- usage time max. 72 hours (3 days)
- is suitable for high pressure applications up to 2 bar
- handle with arrows indicating the flow direction
- 360-degree rotation
- compatibility with Luer Lock cones that meet the requirements of the ČSN EN ISO 80369-7 standard
- PVC free, and DEHP exposure prevention

Three-way tap are intended for concomitant infusion therapies when administering infusions or drugs and can also be used for blood collection. They are designed for pressure and gravity applications up to a pressure of 2 bar for a maximum of 72 hours (3 days). They allow you to set, control, control or stop the desired direction of fluid flow. The three-way tap is compatible with common fluids used in infusion therapy, anesthesia, monitoring, as well as lipid-containing solutions. The color coding of the taps facilitates the identification of individual infusion lines or treatment applications. Three-way taps are compatible with Luer-Lock cones that meet the requirements of the ČSN EN ISO 80369-7 standard.

Three-way tap-blue NO PVC

| | |
|----------------------|------------------------------------|
| Product No.: | V696435 |
| Name (abbreviation): | Three-way tap-blue NO PVC |
| Version: | Sterile-EO |
| Group packaging: | 10 pack x 50 pcs |
| Shipping packaging: | 500 pcs/carton 12.000 pcs/pallet |



Description:

- lipid resistance
- one Male Luer Lock connection end with swivel nut and two Female Luer Lock ends
- All connection ends are protected by covers to maintain sterility
- blue colour to indicate the intravenous line
- transparent material allows flow and flush monitoring
- usage time max. 72 hours (3 days)
- is suitable for high pressure applications up to 2 bar
- handle with arrows indicating the flow direction
- 360-degree rotation
- compatibility with Luer Lock cones that meet the requirements of the ČSN EN ISO 80369-7 standard
- PVC free, and DEHP exposure prevention

Three-way tap are intended for concomitant infusion therapies when administering infusions or drugs and can also be used for blood collection. They are designed for pressure and gravity applications up to a pressure of 2 bar for a maximum of 72 hours (3 days). They allow you to set, control, control or stop the desired direction of fluid flow. The three-way tap is compatible with common fluids used in infusion therapy, anesthesia, monitoring, as well as lipid-containing solutions. The color coding of the taps facilitates the identification of individual infusion lines or treatment applications. Three-way taps are compatible with Luer-Lock cones that meet the requirements of the ČSN EN ISO 80369-7 standard.

Three-way tap - white NO PVC

| | |
|----------------------|------------------------------------|
| Product No.: | V696442 |
| Name (abbreviation): | Three-way tap - white NO PVC |
| Version: | Sterile-EO |
| Group packaging: | 10 pack x 50 pcs |
| Shipping packaging: | 500 pcs/carton 12.000 pcs/pallet |

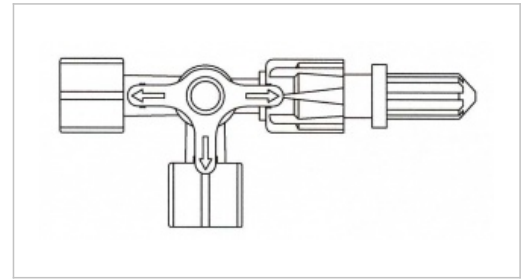

Description:

- lipid resistance
- one Male Luer Lock connection end with swivel nut and two Female Luer Lock ends
- All connection ends are protected by covers to maintain sterility
- transparent material allows flow and flush monitoring
- usage time max. 72 hours (3 days)
- is suitable for high pressure applications up to 2 bar
- handle with arrows indicating the flow direction
- 360-degree rotation
- compatibility with Luer Lock cones that meet the requirements of the ČSN EN ISO 80369-7 standard
- PVC free, and DEHP exposure prevention

Three-way tap are intended for concomitant infusion therapies when administering infusions or drugs and can also be used for blood collection. They are designed for pressure and gravity applications up to a pressure of 2 bar for a maximum of 72 hours (3 days). They allow you to set, control, control or stop the desired direction of fluid flow. The three-way tap is compatible with common fluids used in infusion therapy, anesthesia, monitoring, as well as lipid-containing solutions. The color coding of the taps facilitates the identification of individual infusion lines or treatment applications. Three-way taps are compatible with Luer-Lock cones that meet the requirements of the ČSN EN ISO 80369-7 standard.

Ramp-3 taps NO PVC

| | |
|----------------------|-----------------------------------|
| Product No.: | V696436 |
| Name (abbreviation): | Ramp-3 taps NO PVC |
| Version: | Sterile-EO |
| Group packaging: | - |
| Shipping packaging: | 200 pcs/carton 3.600 pcs/pallet |

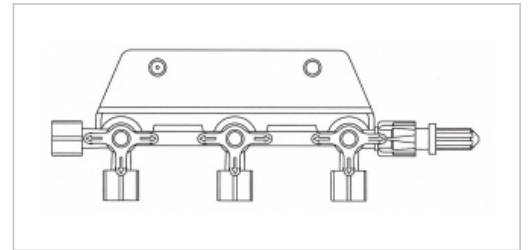

Description:

- lipid resistance
- Male Luer Lock connection end with swivel nut for connection to the patient supply
- four female Luer Lock connection ends for connection to the infusion solution supply
- All connection ends are protected by covers to maintain sterility
- transparent material allows flow and flush monitoring
- usage time max. 72 hours (3 days)
- is suitable for high pressure applications up to 1.5 bar
- rotary taps with arrows indicating the flow direction
- 360 degree rotation of the taps
- compatibility with Luer Lock cones that meet the requirements of the ČSN EN ISO 80369-7 standard
- PVC free, and DEHP exposure prevention

The ramps are designed for simultaneous infusion therapies to administer infusions or drugs. They allow configuration, management, control or suspension of the fluid's desired flow direction. They are designed for both pressure and gravity applications up to a pressure of 1.5 bar for up to 72 hours (3 days). The ramps are compatible with all fluids used in infusion therapy, anaesthesia, monitoring as well as with solutions containing lipids. Colour coding of the taps makes it easy to identify individual infusion lines. The ramps are compatible with Luer-Lock cones, which meet the requirements of ČSN EN ISO 80369-7.

Ramp-5 taps NO PVC

| | |
|----------------------|-----------------------------------|
| Product No.: | V696437 |
| Name (abbreviation): | Ramp-5 taps NO PVC |
| Version: | Sterile-EO |
| Group packaging: | - |
| Shipping packaging: | 200 pcs/carton 3.600 pcs/pallet |

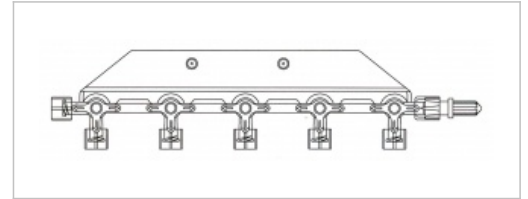

Description:

- lipid resistance
- Male Luer Lock connection end with swivel nut for connection to the patient supply
- six Female Luer Lock connection ends for connection to the infusion solution supply
- All connection ends are protected by covers to maintain sterility
- transparent material allows flow and flush monitoring
- usage time max. 72 hours (3 days)
- is suitable for high pressure applications up to 1.5 bar
- rotary taps with arrows indicating the flow direction
- 360 degree rotation of the taps
- compatibility with Luer Lock cones that meet the requirements of the ČSN EN ISO 80369-7 standard
- PVC free, and DEHP exposure prevention

The ramps are designed for simultaneous infusion therapies to administer infusions or drugs. They allow configuration, management, control or suspension of the fluid's desired flow direction. They are designed for both pressure and gravity applications up to a pressure of 1.5 bar for up to 72 hours (3 days). The ramps are compatible with all fluids used in infusion therapy, anaesthesia, monitoring as well as with solutions containing lipids. Colour coding of the taps makes it easy to identify individual infusion lines. The ramps are compatible with Luer-Lock cones, which meet the requirements of ČSN EN ISO 80369-7.

Ramp 3-way with NP NO PVC

| | |
|----------------------|-----------------------------------|
| Product No.: | V696423 |
| Name (abbreviation): | Ramp 3-way with NP NO PVC |
| Version: | Sterile-EO |
| Group packaging: | - |
| Shipping packaging: | 200 pcs/carton 3.600 pcs/pallet |



Description:

- lipid resistance
- usage time max. 7 days or 100 connections (one needleless input = 100 connections)
- closed system for a high degree of protection against the risk of infection of patients and staff
- is suitable for high pressure applications up to 1.5 bar
- Male Luer Lock connection end with swivel nut for connection to the patient supply
- connection ends for connecting infusion lines equipped with four needleless inputs
- compatible with Luer Slip and Luer Lock
- transparent material allows flow and flush monitoring
- maintains a tight joint even during long-term application
- rotary taps with arrows indicating the flow direction
- three 360 ° swivel taps
- PVC free, and DEHP exposure prevention

The needleless port ramps (hereinafter referred to as the Ramp) are designed for simultaneous infusion therapies to administer infusions or drugs. The ramp is designed for connection to the central venous catheter for pressure and gravity applications at the pressure of up to 1.5 bar. It allows configuration, management, control or suspension of the fluid's desired flow direction. The needleless connection cones are compatible with Luer cones. The ramp must be always replaced no later than after 7 days or 100 connections (one needleless port = 100 connections).

Ramp 5-way with NP NO PVC

| | |
|----------------------|-----------------------------------|
| Product No.: | V696425 |
| Name (abbreviation): | Ramp 5-way with NP NO PVC |
| Version: | Sterile-EO |
| Group packaging: | - |
| Shipping packaging: | 200 pcs/carton 3.600 pcs/pallet |

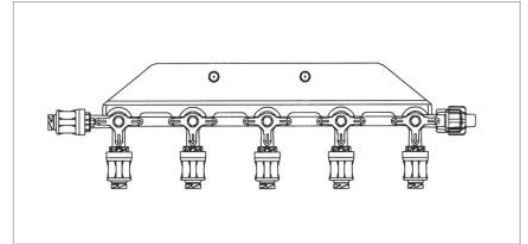

Description:

- lipid resistance
- usage time max. 7 days or 100 connections (one needleless input = 100 connections)
- closed system for a high degree of protection against the risk of infection of patients and staff
- is suitable for high pressure applications up to 1.5 bar
- Male Luer Lock connection end with swivel nut for connection to the patient supply
- connection ends for connecting infusion lines equipped with six needleless inputs
- compatible with Luer Slip and Luer Lock
- transparent material allows flow and flush monitoring
- maintains a tight joint even during long-term application
- rotary taps with arrows indicating the flow direction
- five 360 ° swivel taps
- PVC free, and DEHP exposure prevention

The needleless port ramps (hereinafter referred to as the Ramp) are designed for simultaneous infusion therapies to administer infusions or drugs. The ramp is designed for connection to the central venous catheter for pressure and gravity applications at the pressure of up to 1.5 bar. It allows configuration, management, control or suspension of the fluid's desired flow direction. The needleless connection cones are compatible with Luer cones. The ramp must be always replaced no later than after 7 days or 100 connections (one needleless port = 100 connections).

Other

The double- ended piercing spikes are designed for the transfer, dilution, mixing of sterile solutions or medicaments in a closed system between two containers (bottles) which are closed with a rubber stopper.

The safety valves are intended for taking blood samples using a syringe and needle or for intermittent medicaments injections. The rubber stopper is made of latex-free material, allows reusable use and provides protection against bacterial contamination.

Double-ended piercing spike NO PVC

| | |
|----------------------|------------------------------------|
| Product No.: | V696439 |
| Name (abbreviation): | Double-ended piercing spike NO PVC |
| Version: | Sterile-EO |
| Group packaging: | - |
| Shipping packaging: | 250 ks/carton 9.000 ks/pallets |



Description:

- anatomically shaped grip part
- both ends terminated with the piercing spike
- protective covers against damage to the tip of the spikes

A single use medical device designed to transfer, dilute, mix sterile solutions or drugs in a closed system between two containers (bottles) that are closed with a rubber stopper.

Safety valve NO PVC

| | |
|----------------------|------------------------------------|
| Product No.: | V696433 |
| Name (abbreviation): | Safety valve NO PVC |
| Version: | Sterile-EO |
| Group packaging: | 10 pack x 50 pcs |
| Shipping packaging: | 500 pcs/carton 12.000 pcs/pallet |



Description:

- Male Luer Lock connection end
- part for injection with latex-free membrane
- for immediate repeatable injection of medicines
- can be used for gravity and pressure infusion systems up to 2 bar

Single use medical device intended for intermittent injections of drugs using a rubber stopper, made of latex-free material, which allows repeated injection and ensures protection against bacterial contamination. Safety caps can be used for both gravity and pressure infusion systems up to a pressure of 2 bar. The connecting part of the safety lock is compatible with Female Luer Lock cones that meet the requirements of the ČSN EN ISO 80369-7 standard.

Flow regulators

The infusion flow regulator is designed to regulate the flow of gravity infusion. It can be used for physiological solutions with a viscosity of 0.9% NaCl up to 40% glucose solutions. It's universal for connection to all types of infusion sets. It's recommended for use with i.v. 20G cannula.

Flow regulator infusion

| | |
|----------------------|-----------------------------------|
| Product No.: | V606145-ND |
| Name (abbreviation): | Flow regulator infusion |
| Version: | Sterile-EO |
| Group packaging: | 10 pack x 10 pcs |
| Shipping packaging: | 100 pcs/carton 2.400 pcs/pallet |



Description:

- PVC hoses transparent 3.0/4.1 mm, hardness 75 ShA, length 150 mm
- Male Luer Lock connection end for connection to the patient supply
- Female Luer Lock connection end for connection to an infusion set
- All connection ends are protected by covers to maintain sterility
- universal for connection to all types of gravity infusion sets
- latex-free injection part for immediate repeatable by injection of medicines with a needle
- flow regulator with adjustable flow from 10 to 350 ml/hour
- can be used for physiological solutions with a viscosity of 0.9% NaCl up to 40% glucose solutions
- efficiency and accuracy in infusion flow control - dosing accuracy $\pm 10\%$
- no risk of adverse effects of DEHP on the human body
- no risk of allergic reaction to latex from natural rubber
- the design and the principle on which the dosing is based reduces the influence of external factors that affect the dosing accuracy, they're:
 - solution temperature
 - patient's blood pressure
 - patient movements or changes in posture

Disposable medical device for gravity infusion flow control. The flow regulator infusion may be used for saline of viscosity from 0.9% NaCl up to 40% of glucose solution. It is universal for connection to all types of the infusion sets. It is recommended for use with 20G IV cannulas. Adjustable infusion flow rate from 10 to 350 ml/hour.

Transfusion sets

Transfusion sets

The kits are used for the therapeutic transfer of preserved blood, basic blood components, blood substitutes, etc. from bottles or bags into the patient's vein.

Transfusion set TS-203 = blood filter 350 µm

Transfusion set TS-204 = blood filter 200 µm

TS-203

| | |
|----------------------|-----------------------------------|
| Product No.: | V606203-ND |
| Name (abbreviation): | TS-203 |
| Version: | Sterile-EO |
| Group packaging: | - |
| Shipping packaging: | 200 pcs/carton 3.600 pcs/pallet |

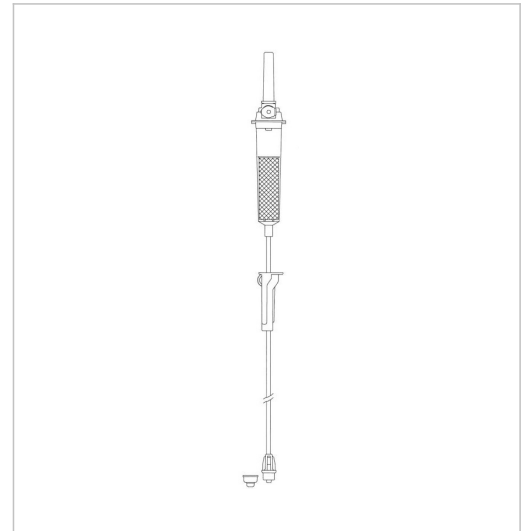

Description:

- the set meets the requirements of the ČSN EN ISO 1135-4 standard
- DEHP-free
- for gravity use
- transparent drip chamber for observing the falling drops
- dropper tube for uniform formation of drops (20 drops = 1 ± 0.1 ml)
- mean for supplying air (aerator) equipped with an air, hydrophobic filter against the ingress of microorganisms (filter porosity 3.0 mm)
- tube size 3.0/4.2 mm, length 1500 mm
- blood filter with a porosity of 350 μ m
- flow regulator with holder for fixing the end of the set (solves "Spaghetti syndrome"), flow adjustment in the range from zero to maximum
- connection end with Male Luer Lock thread
- safe and easily removable cover of the piercing spike and connection cone to maintain sterility

Single use medical device intended for therapeutic transferring of preserved blood, basic blood components, blood substitutes etc. From bottles or plastic bags into the patient.

TS-204

| | |
|----------------------|-----------------------------------|
| Product No.: | V606204-ND |
| Name (abbreviation): | TS-204 |
| Version: | Sterile-EO |
| Group packaging: | - |
| Shipping packaging: | 200 pcs/carton 3.600 pcs/pallet |

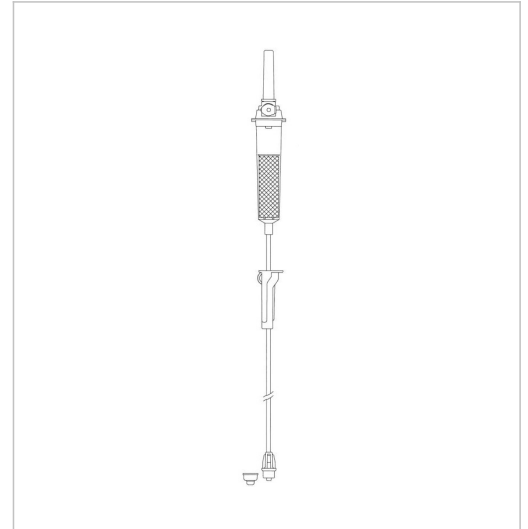

Description:

- the set meets the requirements of the ČSN EN ISO 1135-4 standard
- DEHP-free
- for gravity use
- transparent drip chamber for observing the falling drops
- dropper tube for uniform formation of drops (20 drops = 1 ± 0.1 ml)
- mean for supplying air (aerator) equipped with an air, hydrophobic filter against the ingress of microorganisms (filter porosity 3.0 mm)
- tube size 3.0/4.2 mm, length 1500 mm
- blood filter with a porosity of 200 μ m
- flow regulator with holder for fixing the end of the set (solves "Spaghetti syndrome"), flow adjustment in the range from zero to maximum
- connection end with Male Luer Lock thread
- safe and easily removable cover of the piercing spike and connection cone to maintain sterility

Single use medical device intended for therapeutic transferring of preserved blood, basic blood components, blood substitutes etc. From bottles or plastic bags into the patient.

Plastic extension tubes

GAMAPLUS

A single use medical device intended to extend or connect one or two infusion or transfusion sets to an intravenous needle.

GAMAPLUS 1,8x450 LL

| | |
|----------------------|-----------------------------------|
| Product No.: | V606301-ND |
| Name (abbreviation): | GAMAPLUS 1,8x450 LL |
| Version: | Sterile-EO |
| Group packaging: | 10 pack x 40 pcs |
| Shipping packaging: | 400 pcs/carton 9.600 pcs/pallet |

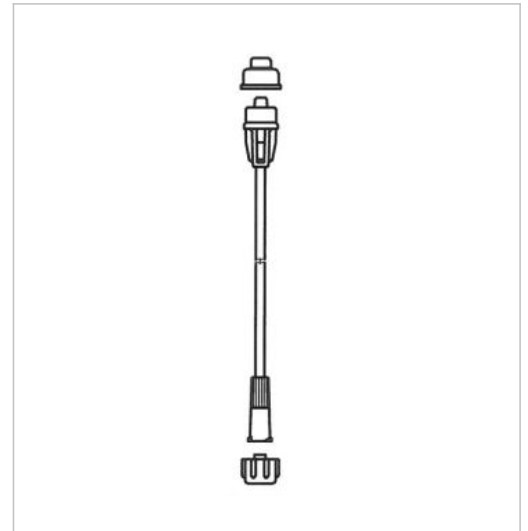

Description:

- the set meets the requirements of the ČSN EN ISO 8536-9 standard
- DEHP-free
- can be used for high-pressure applications up to 2 bar
- tube size 1.9/2.9 mm, length 450 mm
- connection ends with Male Luer Lock and Female Luer Lock threads
- both connection ends are protected by covers to maintain sterility
- the threaded design of the connecting cones ensures a firm and tight connection when the patient moves

A single use medical device intended to extend or connect one or two infusion or transfusion sets to an intravenous needle.

GAMAPLUS 1,8x450 LLK

| | |
|----------------------|-----------------------------------|
| Product No.: | V606301-01ND |
| Name (abbreviation): | GAMAPLUS 1,8x450 LLK |
| Version: | Sterile-EO |
| Group packaging: | 10 pack x 40 pcs |
| Shipping packaging: | 400 pcs/carton 9.600 pcs/pallet |



Description:

- the set meets the requirements of the ČSN EN ISO 8536-9 standard
- DEHP-free
- can be used for high-pressure applications up to 2 bar
- tube size 1.9/2.9 mm, length 450 mm
- connection ends with Male Luer Lock and Female Luer Lock threads
- the connection end of the Female Luer Lock is equipped with wings for easier tightening and loosening of the connection
- both connection ends are protected by covers to maintain sterility
- the threaded design of the connecting cones ensures a firm and tight connection when the patient moves

A single use medical device intended to extend or connect one or two infusion or transfusion sets to an intravenous needle.

GAMAPLUS 1,8x450 UNIV

| | |
|----------------------|-----------------------------------|
| Product No.: | V606306-ND |
| Name (abbreviation): | GAMAPLUS 1,8x450 UNIV |
| Version: | Sterile-EO |
| Group packaging: | 10 pack x 40 pcs |
| Shipping packaging: | 400 pcs/carton 9.600 pcs/pallet |

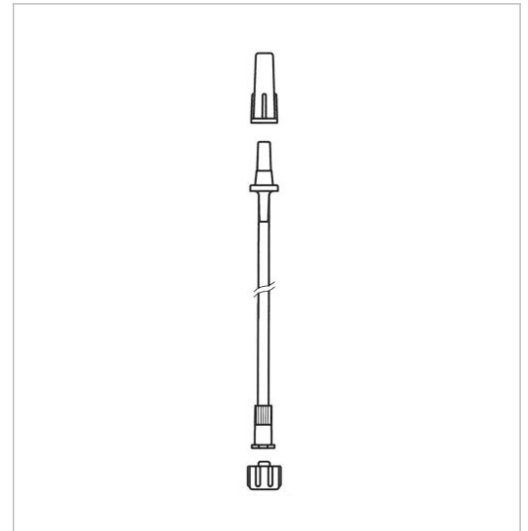

Description:

- the set meets the requirements of the ČSN EN ISO 8536-9 standard
- DEHP-free
- can be used for high-pressure applications up to 2 bar
- tube size 1.9/2.9 mm, length 450 mm
- connection end without Male Luer thread
- connection end with Female Luer Lock thread
- both connection ends are protected by covers to maintain sterility

A single use medical device intended to extend or connect one or two infusion or transfusion sets to an intravenous needle.

GAMAPLUS 1,8x1800 LL

| | |
|----------------------|-----------------------------------|
| Product No.: | V606304-ND |
| Name (abbreviation): | GAMAPLUS 1,8x1800 LL |
| Version: | Sterile-EO |
| Group packaging: | 10 pack x 20 pcs |
| Shipping packaging: | 200 pcs/carton 4.800 pcs/pallet |



Description:

- the set meets the requirements of the ČSN EN ISO 8536-9 standard
- DEHP-free
- can be used for high-pressure applications up to 2 bar
- tube size 1.9/2.9 mm, length 1800 mm
- connection ends with Male Luer Lock and Female Luer Lock threads
- both connection ends are protected by covers to maintain sterility
- the threaded design of the connecting cones ensures a firm and tight connection when the patient moves

A single use medical device intended to extend or connect one or two infusion or transfusion sets to an intravenous needle.

GAMAPLUS 1,8x1800 LLK

| | |
|----------------------|-----------------------------------|
| Product No.: | V606304-01ND |
| Name (abbreviation): | GAMAPLUS 1,8x1800 LLK |
| Version: | Sterile-EO |
| Group packaging: | 10 pack x 20 pcs |
| Shipping packaging: | 200 pcs/carton 4.800 pcs/pallet |

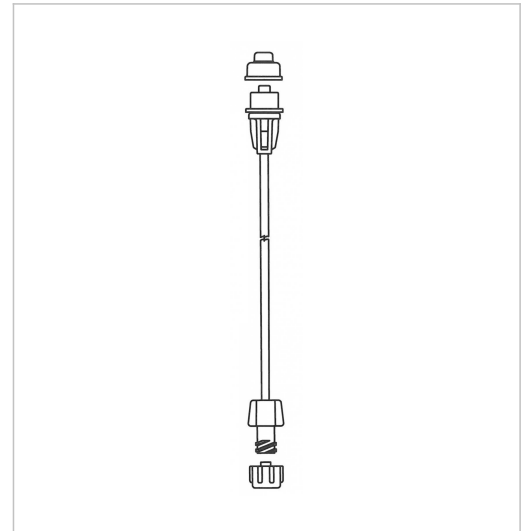

Description:

- the set meets the requirements of the ČSN EN ISO 8536-9 standard
- DEHP-free
- can be used for high-pressure applications up to 2 bar
- tube size 1.9/2.9 mm, length 1800 mm
- connection ends with Male Luer Lock and Female Luer Lock threads
- the connection end of the Female Luer Lock is equipped with wings for easier tightening and loosening of the connection
- both connection ends are protected by covers to maintain sterility
- the threaded design of the connecting cones ensures a firm and tight connection when the patient moves

A single use medical device intended to extend or connect one or two infusion or transfusion sets to an intravenous needle.

GAMAPLUS 1,8x1800 UNIV

| | |
|----------------------|-----------------------------------|
| Product No.: | V606307-ND |
| Name (abbreviation): | GAMAPLUS 1,8x1800 UNIV |
| Version: | Sterile-EO |
| Group packaging: | 10 pack x 20 pcs |
| Shipping packaging: | 200 pcs/carton 4.800 pcs/pallet |

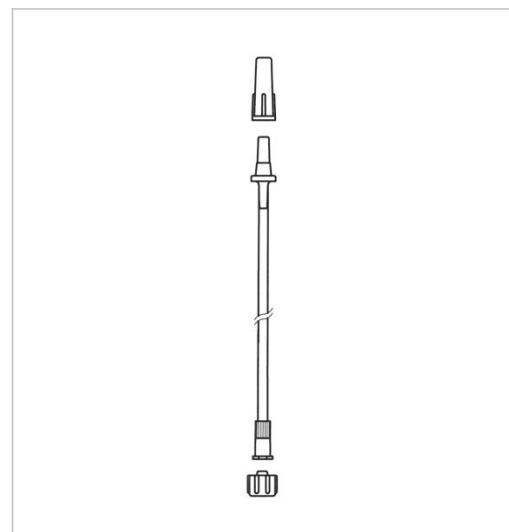

Description:

- the set meets the requirements of the ČSN EN ISO 8536-9 standard
- DEHP-free
- can be used for high-pressure applications up to 2 bar
- tube size 1.9/2.9 mm, length 1800 mm
- connection end without Male Luer thread
- connection end with Female Luer Lock thread
- both connection ends are protected by covers to maintain sterility

A single use medical device intended to extend or connect one or two infusion or transfusion sets to an intravenous needle.

GAMAPLUS 3,0x150 LL

| | |
|----------------------|-----------------------------------|
| Product No.: | V606321-ND |
| Name (abbreviation): | GAMAPLUS 3,0x150 LL |
| Version: | Sterile-EO |
| Group packaging: | 10 pack x 30 pcs |
| Shipping packaging: | 300 pcs/carton 7.200 pcs/pallet |

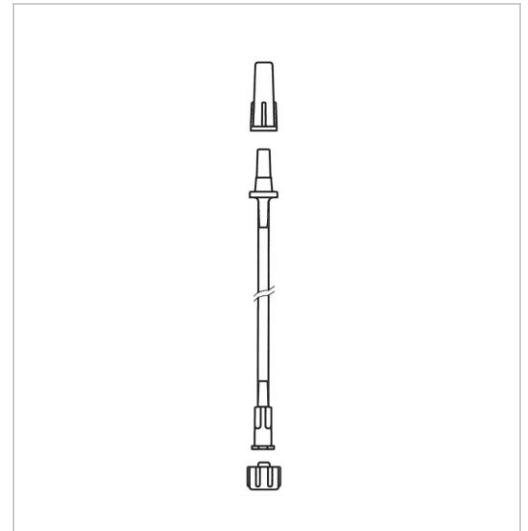

Description:

- the set meets the requirements of the ČSN EN ISO 8536-9 standard
- DEHP-free
- can be used for high-pressure applications up to 2 bar
- tube size 3.0/4.2 mm, length 150 mm
- connection end without Male Luer thread
- connection end with Female Luer Lock thread
- both connection ends are protected by covers to maintain sterility

A single use medical device intended to extend or connect one or two infusion or transfusion sets to an intravenous needle.

GAMAPLUS 3,0x300 LL

| | |
|----------------------|-----------------------------------|
| Product No.: | V606342-ND |
| Name (abbreviation): | GAMAPLUS 3,0x300 LL |
| Version: | Sterile-EO |
| Group packaging: | 10 pack x 30 pcs |
| Shipping packaging: | 300 pcs/carton 7.200 pcs/pallet |



Description:

- the set meets the requirements of the ČSN EN ISO 8536-9 standard
- DEHP-free
- can be used for high-pressure applications up to 2 bar
- tube size 3.0/4.2 mm, length 300 mm
- connection end without Male Luer thread
- connection end with Female Luer Lock thread
- both connection ends are protected by covers to maintain sterility

A single use medical device intended to extend or connect one or two infusion or transfusion sets to an intravenous needle.

GAMAPLUS 3,0x2500 LL

| | |
|----------------------|-----------------------------------|
| Product No.: | V606347-ND |
| Name (abbreviation): | GAMAPLUS 3,0x2500 LL |
| Version: | Sterile-EO |
| Group packaging: | - |
| Shipping packaging: | 100 pcs/carton 2.400 pcs/pallet |



Description:

- the set meets the requirements of the ČSN EN ISO 8536-9 standard
- DEHP-free
- can be used for high-pressure applications up to 2 bar
- tube size 3.0/4.2 mm, length 2500 mm
- connection end without Male Luer thread
- connection end with Female Luer Lock thread
- both connection ends are protected by covers to maintain sterility

A single use medical device intended to extend or connect one or two infusion or transfusion sets to an intravenous needle.

GAMAPLUS 3,0x3500 LL

| | |
|----------------------|-----------------------------------|
| Product No.: | V606349-ND |
| Name (abbreviation): | GAMAPLUS 3,0x3500 LL |
| Version: | Sterile-EO |
| Group packaging: | - |
| Shipping packaging: | 100 pcs/carton 2.400 pcs/pallet |



Description:

- the set meets the requirements of the ČSN EN ISO 8536-9 standard
- DEHP-free
- can be used for high-pressure applications up to 2 bar
- tube size 3.0/4.2 mm, length 3500 mm
- connection end without Male Luer thread
- connection end with Female Luer Lock thread
- both connection ends are protected by covers to maintain sterility

A single use medical device intended to extend or connect one or two infusion or transfusion sets to an intravenous needle.

GAMAPLUS 3,0x150 YLL

| | |
|----------------------|-----------------------------------|
| Product No.: | V606371-ND |
| Name (abbreviation): | GAMAPLUS 3,0x150 YLL |
| Version: | Sterile-EO |
| Group packaging: | 10 pack x 30 pcs |
| Shipping packaging: | 300 pcs/carton 7.200 pcs/pallet |



Description:

- the set meets the requirements of the ČSN EN ISO 8536-9 standard
- DEHP-free
- can be used for high-pressure applications up to 2 bar
- two tubes of size 3.0/4.2 mm, length 150 mm
- one connection end without Male Luer thread
- two connection ends with Female Luer Lock thread
- all connection ends are protected by covers to maintain sterility

A single use medical device intended to extend or connect one or two infusion or transfusion sets to an intravenous needle.

GAMAPLUS 3,0x150 LCH

| | |
|----------------------|-----------------------------------|
| Product No.: | V606372-ND |
| Name (abbreviation): | GAMAPLUS 3,0x150 LCH |
| Version: | Sterile-EO |
| Group packaging: | 10 pack x 30 pcs |
| Shipping packaging: | 300 pcs/carton 7.200 pcs/pallet |



Description:

- the set meets the requirements of the ČSN EN ISO 8536-9 standard
- DEHP-free
- can be used for applications up to 0.5 bar pressure
- tube 3.0/4.2 mm, length 150 mm
- connection end without Male Luer thread
- connecting end funnel end Charrière Ch12 white

A single use medical device intended to extend or connect one or two infusion or transfusion sets to an intravenous needle.

GAMAPLUS 1,8x1500 LL

| | |
|----------------------|-----------------------------------|
| Product No.: | V606303-ND |
| Name (abbreviation): | GAMAPLUS 1,8x1500 LL |
| Version: | Sterile-EO |
| Group packaging: | 10 pack x 20 pcs |
| Shipping packaging: | 200 pcs/carton 4.800 pcs/pallet |

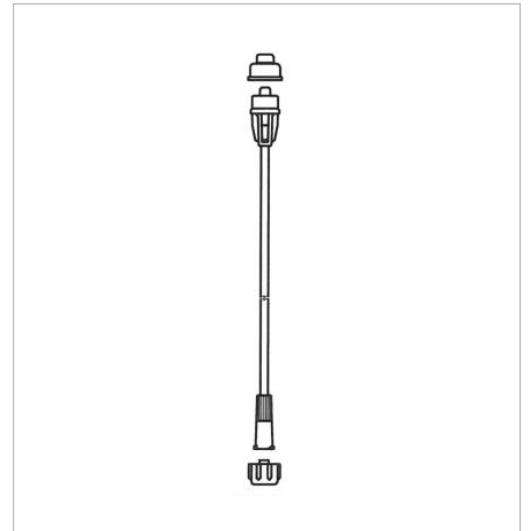

Description:

- the set meets the requirements of the ČSN EN ISO 8536-9 standard
- DEHP-free
- can be used for high-pressure applications up to 2 bar
- tube size 1.9/2.9 mm, length 1500 mm
- connection ends with Male Luer Lock and Female Luer Lock threads
- both connection ends are protected by covers to maintain sterility
- the threaded design of the connecting cones ensures a firm and tight connection when the patient moves

A single use medical device intended to extend or connect one or two infusion or transfusion sets to an intravenous needle.

GAMAPLUS 4,5 x 20 LCH

| | |
|----------------------|-----------------------------------|
| Product No.: | V606372-01ND |
| Name (abbreviation): | GAMAPLUS 4,5 x 20 LCH |
| Version: | Sterile-EO |
| Group packaging: | 10 pack x 40 pcs |
| Shipping packaging: | 400 pcs/carton 9.600 pcs/pallet |

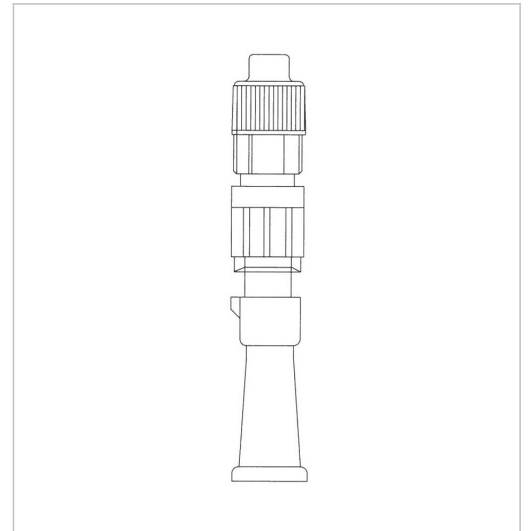

Description:

- the set meets the requirements of the ČSN EN ISO 8536-9 standard
- DEHP-free
- can be used for applications up to 0.5 bar pressure
- tube 4.5/6.8 mm, length 20 mm
- male Luer Lock threaded connection end
- connecting end funnel end Charrière Ch20 yellow

A single use medical device intended to extend or connect one or two infusion or transfusion sets to an intravenous needle.

Connection Tubings

Single use medical devices designed to connect multiple infusion sets to other components such as i.v. cannula. One or more infusion solutions or drug solutions can be administered simultaneously via the inlets of the connecting tubes that form the Luer Lock connection connectors. The connecting Tubings are designed for pressure and gravity systems up to a pressure of 2 bar and are compatible with Luer Lock cones that meet the requirements of the ČSN EN ISO 80369-7 standard.

Connecting Tubing 2-way

| | |
|----------------------|-----------------------------------|
| Product No.: | V606402-ND |
| Name (abbreviation): | Connecting Tubing 2-way |
| Version: | Sterile-EO |
| Group packaging: | 4 pack x 50 pcs |
| Shipping packaging: | 200 pcs/carton 3.600 pcs/pallet |

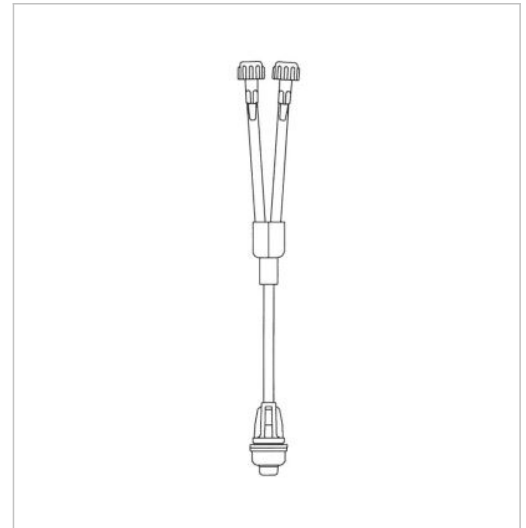

Description:

- the set meets the requirements of the ČSN EN ISO 8536-9 standard
- DEHP-free
- can be used for applications up to 2 bar pressure
- transparent PVC tube 3.0/4.1 mm, length 60 mm
- threaded connection ends 2x Female Luer Lock, 1x Male Luer Lock
- the connection ends are protected by covers to maintain sterility
- the threaded design of the connecting cones ensures a firm and tight connection when the patient moves

Single use medical devices designed to connect multiple infusion sets to other components such as i.v. cannula. One or more infusion solutions or drug solutions can be administered simultaneously via the inlets of the connecting tubes that form the Luer Lock connection connectors. The connecting Tubings are designed for pressure and gravity systems up to a pressure of 2 bar and are compatible with Luer Lock cones that meet the requirements of the ČSN EN ISO 80369-7 standard.

Connecting Tubing 4-way

| | |
|----------------------|-----------------------------------|
| Product No.: | V606404-ND |
| Name (abbreviation): | Connecting Tubing 4-way |
| Version: | Sterile-EO |
| Group packaging: | 4 pack x 50 pcs |
| Shipping packaging: | 200 pcs/carton 3.600 pcs/pallet |

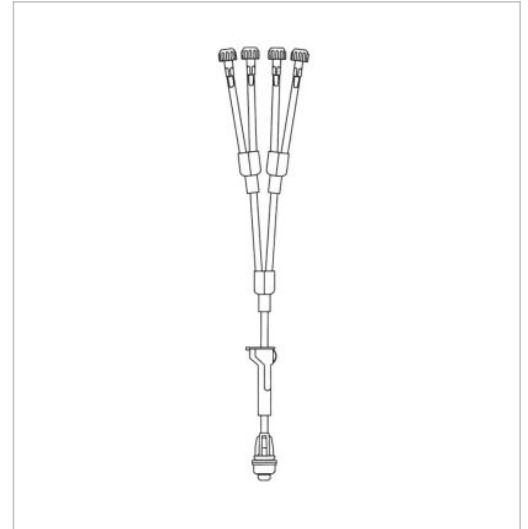

Description:

- the set meets the requirements of the ČSN EN ISO 8536-9 standard
- DEHP-free
- can be used for applications up to 2 bar pressure
- transparent PVC tube 3.0/4.1 mm, length 60 mm and 200 mm
- threaded connection ends 4x Female Luer Lock, 1x Male Luer Lock
- the connection ends are protected by covers to maintain sterility
- the threaded design of the connecting cones ensures a firm and tight connection when the patient moves
- flow regulator with settings from zero to maximum

Single use medical devices designed to connect multiple infusion sets to other components such as i.v. cannula. One or more infusion solutions or drug solutions can be administered simultaneously via the inlets of the connecting tubes that form the Luer Lock connection connectors. The connecting Tubings are designed for pressure and gravity systems up to a pressure of 2 bar and are compatible with Luer Lock cones that meet the requirements of the ČSN EN ISO 80369-7 standard.

Connection tubing with needleless port

| | |
|----------------------|--|
| Product No.: | V686424-ND |
| Name (abbreviation): | Connection tubing with needleless port |
| Version: | Sterile-EO |
| Group packaging: | 10 pack x 40 pcs |
| Shipping packaging: | 400 pcs/carton 9.600 pcs/pallet |



Description:

- the set meets the requirements of the ČSN EN ISO 8536-9 standard
- DEHP-free
- it is intended for pressure and gravity systems up to a pressure of 2 bars
- the maximum useful life is determined by the useful life of the catheter to which it is connected, but its replacement must always be done after a maximum of 7 days or after 100 connections
- transparent PVC tube 1.0/2.4 mm, length 120 mm
- connection end with Male Luer Lock thread for connection to the patient line
- connection end with needle-free entry for connecting infusion accessories
- compatible with Luer Slip and Luer Lock
- slotted pressure to stop the flow

The Connection tubing with needleless port is a single use medical device designed to connect i.v. cannulas with other Luer-terminated infusion systems (syringes, infusion sets, etc.). It can also be used to extend or interconnect any infusion system that has a Luer termination. The Connection tubing with needleless port provides a closed system and thus microbiological safety for the life of the i.v. cannula to which it is connected or max. 100 applications. The needle-free inlet at which the tube ends allows multiple and safe access (without the use of a needle) for direct injection or infusion. The Connection tubing with needleless port is designed for pressure and gravity systems up to a pressure of 2 bar.

Extension PVC tubings

Single use medical devices intended as connecting tubes for linear dispensers in intravenous or intra-arterial infusion therapy. Tubing terminations on both ends of the Luer Lock cone ensure a secure connection to a standard syringe designed for a linear dispenser and to an intravenous or intra-arterial catheter. Furthermore, this tubing can be used as a standard extension tubing to connect an infusion set to an intravenous needle. The PVC extension tube, for light-sensitive drugs, also allows you to administer drugs that are sensitive to light. The connection cones of the extension tube are compatible with Luer Lock cones that meet the requirements of the ČSN EN ISO 80369-7 standard.

150 cm, extension PVC tube for light-sensitive drugs

| | |
|----------------------|--|
| Product No.: | V686423-ND |
| Name (abbreviation): | 150 cm, extension PVC tube for light-sensitive drugs |
| Version: | Sterile-EO |
| Group packaging: | 10 pack x 20 pcs |
| Shipping packaging: | 200 pcs/carton 4.800 pcs/pallet |

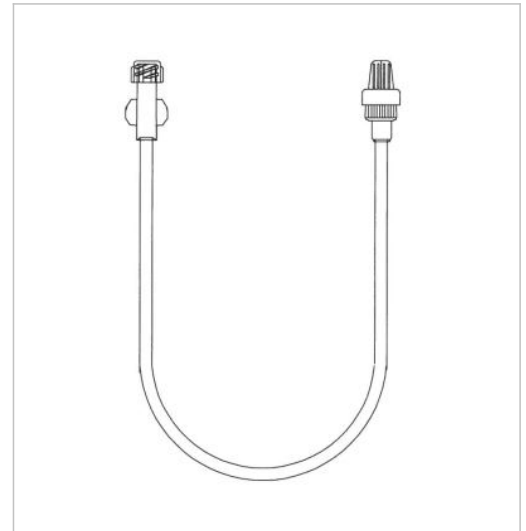

Description:

- the set meets the requirements of the ČSN EN ISO 8536-9 standard
- DEHP-free
- is intended for the application of light-sensitive drugs
- is compatible with a standard syringe designed for a linear dispenser
- can be used for applications up to 2 bar pressure
- tube 1.5/2.7 mm, length 1500 mm
- transparent tube with a yellow colour provides protection against UV radiation
- connection ends with Male Luer Lock and Female Luer Lock threads
- the connection end of the Female Luer Lock is equipped with wings for easier tightening and loosening of the connection
- both connection ends are protected by covers to maintain sterility
- the threaded design of the connecting cones ensures a firm and tight connection when the patient moves

Single use medical devices intended as connecting tubes for linear dispensers in intravenous or intra-arterial infusion therapy. Tubing terminations on both ends of the Luer Lock cone ensure a secure connection to a standard syringe designed for a linear dispenser and to an intravenous or intra-arterial catheter. Furthermore, this tubing can be used as a standard extension tubing to connect an infusion set to an intravenous needle. The PVC extension tube, for light-sensitive drugs, also allows you to administer drugs that are sensitive to light. The connection cones of the extension tube are compatible with Luer Lock cones that meet the requirements of the ČSN EN ISO 80369-7 standard.

150 cm, extension PVC tube

| | |
|----------------------|-----------------------------------|
| Product No.: | V606502-ND |
| Name (abbreviation): | 150 cm, extension PVC tube |
| Version: | Sterile-EO |
| Group packaging: | 10 pack x 20 pcs |
| Shipping packaging: | 200 pcs/carton 4.800 pcs/pallet |



Single use medical devices intended as connecting tubes for linear dispensers in intravenous or intra-arterial infusion therapy. Tubing terminations on both ends of the Luer Lock cone ensure a secure connection to a standard syringe designed for a linear dispenser and to an intravenous or intra-arterial catheter. Furthermore, this tubing can be used as a standard extension tubing to connect an infusion set to an intravenous needle. The PVC extension tube, for light-sensitive drugs, also allows you to administer drugs that are sensitive to light. The connection cones of the extension tube are compatible with Luer Lock cones that meet the requirements of the ČSN EN ISO 80369-7 standard.

PVC extension tube, 200 cm for light-sensitive drugs

| | |
|----------------------|--|
| Product No.: | V686423-01ND |
| Name (abbreviation): | PVC extension tube, 200 cm for light-sensitive drugs |
| Version: | Sterile-EO |
| Group packaging: | 10 pack x 20 pcs |
| Shipping packaging: | 200 pcs/carton 4.800 pcs/pallet |

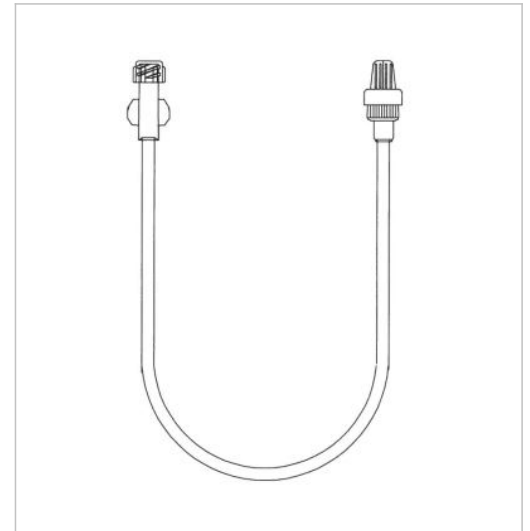

Description:

- the set meets the requirements of the ČSN EN ISO 8536-9 standard
- DEHP-free
- is intended for the application of light-sensitive drugs
- is compatible with a standard syringe designed for a linear dispenser
- can be used for applications up to 2 bar pressure
- tube 1.5/2.7 mm, length 2000 mm
- transparent tube with a yellow colour provides protection against UV radiation
- connection ends with Male Luer Lock and Female Luer Lock threads
- the connection end of the Female Luer Lock is equipped with wings for easier tightening and loosening of the connection
- both connection ends are protected by covers to maintain sterility
- the threaded design of the connecting cones ensures a firm and tight connection when the patient moves

Single use medical devices intended as connecting tubes for linear dispensers in intravenous or intra-arterial infusion therapy. Tubing terminations on both ends of the Luer Lock cone ensure a secure connection to a standard syringe designed for a linear dispenser and to an intravenous or intra-arterial catheter. Furthermore, this tubing can be used as a standard extension tubing to connect an infusion set to an intravenous needle. The PVC extension tube, for light-sensitive drugs, also allows you to administer drugs that are sensitive to light. The connection cones of the extension tube are compatible with Luer Lock cones that meet the requirements of the ČSN EN ISO 80369-7 standard.

PVC extension tube, 50 cm for light-sensitive drugs

| | |
|----------------------|---|
| Product No.: | V686423-02ND |
| Name (abbreviation): | PVC extension tube, 50 cm for light-sensitive drugs |
| Version: | Sterile-EO |
| Group packaging: | 10 pack x 40 pcs |
| Shipping packaging: | 400 pcs/carton 9.600 pcs/pallet |

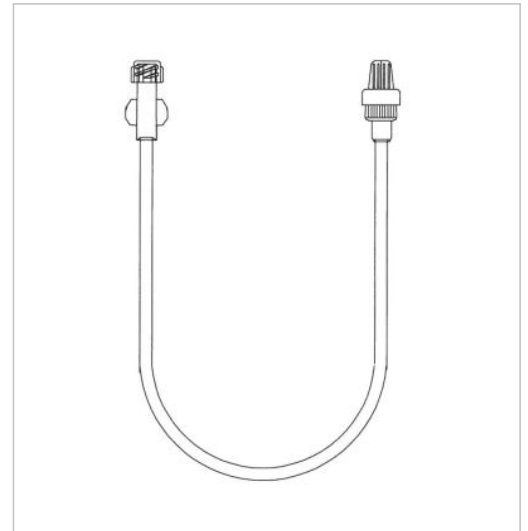

Description:

- the set meets the requirements of the ČSN EN ISO 8536-9 standard
- DEHP-free
- is intended for the application of light-sensitive drugs
- is compatible with a standard syringe designed for a linear dispenser
- can be used for applications up to 2 bar pressure
- tube 1.5/2.7 mm, length 500 mm
- transparent tube with a yellow colour provides protection against UV radiation
- connection ends with Male Luer Lock and Female Luer Lock threads
- the connection end of the Female Luer Lock is equipped with wings for easier tightening and loosening of the connection
- both connection ends are protected by covers to maintain sterility
- the threaded design of the connecting cones ensures a firm and tight connection when the patient moves

Single use medical devices intended as connecting tubes for linear dispensers in intravenous or intra-arterial infusion therapy. Tubing terminations on both ends of the Luer Lock cone ensure a secure connection to a standard syringe designed for a linear dispenser and to an intravenous or intra-arterial catheter. Furthermore, this tubing can be used as a standard extension tubing to connect an infusion set to an intravenous needle. The PVC extension tube, for light-sensitive drugs, also allows you to administer drugs that are sensitive to light. The connection cones of the extension tube are compatible with Luer Lock cones that meet the requirements of the ČSN EN ISO 80369-7 standard.

Transfer sets

Transfer sets

Transfer sets are intended for transferring infusion solutions during eye surgeries. The infusion solution is fed into the eye surgery site with a tube with an internal diameter of 3.0 mm, and the excess infusion solution is aspirated by a tube with an internal diameter of 1.9 mm. Each tube is terminated with a negative and a positive cone.

Differentiation of transfer sets by product number:

- transfer set with product number V606386-ND has tubes with a hardness of 75 ShA
- transfer set with product number V606386-02ND has tubes with a hardness of 75 ShA
- transfer set with product number V606386-03ND has tubes with a hardness of 61 ShA

The sets V606386-02ND and V606386-03ND are designed to transfer infusion solutions during eye operations on the Stellaris and Stellaris PC microsurgical instruments. The kits are compatible with the Handpiece Bausch & Lomb.

Transfer set

| | |
|----------------------|-----------------------------------|
| Product No.: | V606386-ND |
| Name (abbreviation): | Transfer set |
| Version: | Sterile-EO |
| Group packaging: | - |
| Shipping packaging: | 150 pcs/carton 2.700 pcs/pallet |



Description:

- aspiration tube with dimensions 1.9/4.1 mm, length 1800 mm
- irrigation tube with dimensions 3.0/4.2 mm, length 1800 mm
- tube hardness 75 ShA
- the aspiration tube has Female Luer Lock and Male Luer Lock threaded connection ends
- the irrigation tubing has a Female Luer Lock threaded connection end and a Male Luer non-threaded end
- the connection ends are protected by covers to maintain sterility
- DEHP-free

Single use medical device for affining of components of infusion solution during eye operations.

Transfer set PS

| | |
|----------------------|-----------------------------------|
| Product No.: | V606386-02ND |
| Name (abbreviation): | Transfer set PS |
| Version: | Sterile-EO |
| Group packaging: | - |
| Shipping packaging: | 150 pcs/carton 2.700 pcs/pallet |

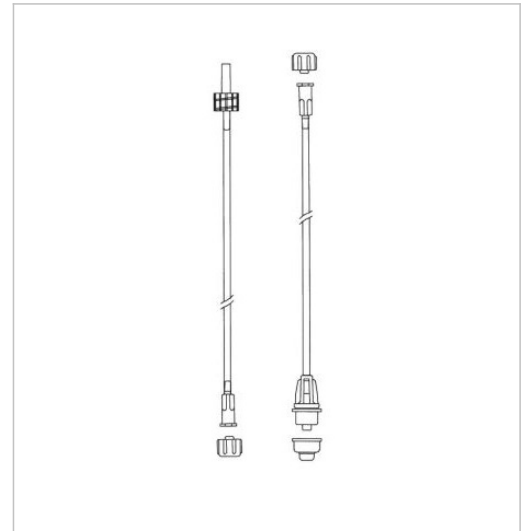

Description:

- use with Stellaris and Stellaris PC microsurgical device
- compatible with Handpiece Bausch & Lomb
- aspiration tube with dimensions 1.9/4.1 mm, length 1800 mm
- irrigation tube with dimensions 3.0/4.2 mm, length 1800 mm
- tube hardness 75 ShA
- the aspiration tube has connecting ends with Female Luer Lock and Male Luer Lock threads (the Female Luer Lock cone is in blue colour)
- the irrigation tube has connecting ends with Female Luer Lock and Male Luer Lock threads (the Male Luer Lock cone is in green colour)
- the connection ends are protected by covers to maintain sterility
- DEHP-free

Single use medical device for affining of components of infusion solution during eye operations.

Transfer set PS

| | |
|----------------------|-----------------------------------|
| Product No.: | V606386-03ND |
| Name (abbreviation): | Transfer set PS |
| Version: | Sterile-EO |
| Group packaging: | - |
| Shipping packaging: | 100 pcs/carton 2.400 pcs/pallet |

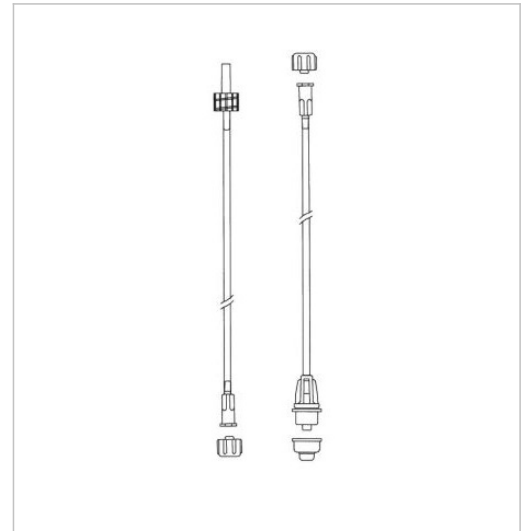

Description:

- use with Stellaris and Stellaris PC microsurgical device
- compatible with Handpiece Bausch & Lomb
- aspiration tube with dimensions 1.9/4.1 mm, length 1800 mm
- irrigation tube with dimensions 3.0/4.2 mm, length 1800 mm
- tube hardness 61 ShA
- the aspiration tube has connecting ends with Female Luer Lock and Male Luer Lock threads (the Female Luer Lock cone is in blue colour)
- the irrigation tube has connecting ends with Female Luer Lock and Male Luer Lock threads (the Male Luer Lock cone is in green colour)
- the connection ends are protected by covers to maintain sterility
- DEHP-free

Single use medical device for affining of components of infusion solution during eye operations.

Accessories for dialysis

Accessories for dialysis

Priming set for the dialysis sets- Single use medical device intended for filling and rinsing dialysis sets and dialyzers before starting hemodialysis, or flushing blood from them when ending hemodialysis with physiological solution or, if necessary, topping up the patient with physiological solution.

Priming set of dialysis sets PS 003

| | |
|----------------------|-------------------------------------|
| Product No.: | V606003-ND |
| Name (abbreviation): | Priming set of dialysis sets PS 003 |
| Version: | Sterile-EO |
| Group packaging: | - |
| Shipping packaging: | 150 pcs/carton 2.700 pcs/pallet |

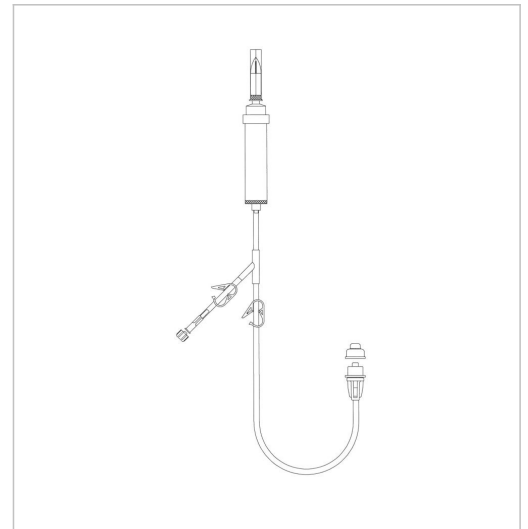

Description:

without collection bag

Urinal aids and accessories

Male urinals with cover

Collecting urine bottles are intended for men. These are bottles of 1000 ml volume from HDPE of various colours and divided scale with 50 ml increments. The bottles have their lid from LDPE and neck diameter is 54 mm.

Male urinal with cover

| | |
|----------------------|--------------------------------|
| Product No.: | V204811 |
| Name (abbreviation): | Male urinal with cover |
| Version: | non sterile |
| Group packaging: | - |
| Shipping packaging: | 30 pcs/carton 540 pcs/pallet |



Description:

white bottle, blue lid from LDPE

Male urinal with cover - green

| | |
|----------------------|--------------------------------|
| Product No.: | V204811-54 |
| Name (abbreviation): | Male urinal with cover - green |
| Version: | non sterile |
| Group packaging: | - |
| Shipping packaging: | 30 pcs/carton 540 pcs/pallet |



Description:
green bottle, green lid from LDPE

Male urinal with cover - blue

| | |
|----------------------|--------------------------------|
| Product No.: | V204811-55 |
| Name (abbreviation): | Male urinal with cover - blue |
| Version: | non sterile |
| Group packaging: | - |
| Shipping packaging: | 30 pcs/carton 540 pcs/pallet |



Description:
blue bottle, blue lid from LDPE

Urine bottles cover

| | |
|----------------------|---------------------|
| Product No.: | V204814 |
| Name (abbreviation): | Urine bottles cover |
| Version: | non sterile |
| Group packaging: | 10 pcs in a PE bag |
| Shipping packaging: | 500 pcs/carton |



Description:

blue LDPE cover

spare part for products Male urinal with cover V204811,V204811-54,V204811-55

Male urinals with cover in a PE bag

| | |
|----------------------|-------------------------------------|
| Product No.: | V204811-02 |
| Name (abbreviation): | Male urinals with cover in a PE bag |
| Version: | Nesterilní |
| Group packaging: | - |
| Shipping packaging: | 25 pcs/carton 450 pcs/pallet |



Description:

white bottle, blue lid from LDPE

Male urinals with cover in a PE bag - green

| | |
|----------------------|---|
| Product No.: | V204811-0254 |
| Name (abbreviation): | Male urinals with cover in a PE bag - green |
| Version: | non sterile |
| Group packaging: | - |
| Shipping packaging: | 25 pcs/carton 450 pcs/pallet |



Description:
green bottle, green lid from LDPE

Male urinal with cover in a PE bag - blue

| | |
|----------------------|---|
| Product No.: | V204811-0255 |
| Name (abbreviation): | Male urinal with cover in a PE bag - blue |
| Version: | non sterile |
| Group packaging: | - |
| Shipping packaging: | 25 pcs/carton 450 pcs/pallet |



Description:
blue bottle, blue lid from LDPE

Urinal conic measuring cups

The cone-shaped urinal measuring cups are intended for taking of so-called medium urine flow for laboratory examination. These are polystyrene cone-shaped measuring cups of 100 ml or 250 ml, with a funnel and scale divided by 10 ml.

Urinal conic measuring cup 100 ml

| | |
|----------------------|-----------------------------------|
| Product No.: | V204808 |
| Name (abbreviation): | Urinal conic measuring cup 100 ml |
| Version: | non sterile |
| Group packaging: | - |
| Shipping packaging: | 36 pcs/carton 2.880 pcs/pallet |



Description:
transparent clear

Urinal conic measuring cup 100 ml - yellow

| | |
|----------------------|--|
| Product No.: | V204808-53 |
| Name (abbreviation): | Urinal conic measuring cup 100 ml - yellow |
| Version: | non sterile |
| Group packaging: | - |
| Shipping packaging: | 36 pcs/carton 2.880 pcs/pallet |



Description:
transparent yellow

Urinal conic measuring cup 100 ml - green

| | |
|----------------------|---|
| Product No.: | V204808-54 |
| Name (abbreviation): | Urinal conic measuring cup 100 ml - green |
| Version: | non sterile |
| Group packaging: | - |
| Shipping packaging: | 36 pcs/carton 2.880 pcs/pallet |



Description:
transparent green

Urinal conic measuring cup 100 ml - blue

| | |
|----------------------|--|
| Product No.: | V204808-55 |
| Name (abbreviation): | Urinal conic measuring cup 100 ml - blue |
| Version: | non sterile |
| Group packaging: | - |
| Shipping packaging: | 36 pcs/carton 2.880 pcs/pallet |



Description:
transparent blue

Urinal conic measuring cup 250 ml

| | |
|----------------------|-----------------------------------|
| Product No.: | V204809 |
| Name (abbreviation): | Urinal conic measuring cup 250 ml |
| Version: | non sterile |
| Group packaging: | - |
| Shipping packaging: | 12 pcs/carton 960 pcs/pallet |



Description:
transparent clear

Urinal conic measuring cup 250 ml - yellow

| | |
|----------------------|--|
| Product No.: | V204809-53 |
| Name (abbreviation): | Urinal conic measuring cup 250 ml - yellow |
| Version: | non sterile |
| Group packaging: | - |
| Shipping packaging: | 12 pcs/carton 960 pcs/pallet |



Description:
transparent yellow

Urinal conic measuring cup 250 ml - green

| | |
|----------------------|---|
| Product No.: | V204809-54 |
| Name (abbreviation): | Urinal conic measuring cup 250 ml - green |
| Version: | non sterile |
| Group packaging: | - |
| Shipping packaging: | 12 pcs/carton 960 pcs/pallet |



Description:
transparent green

Urinal conic measuring cup 250 ml - blue

| | |
|----------------------|--|
| Product No.: | V204809-55 |
| Name (abbreviation): | Urinal conic measuring cup 250 ml - blue |
| Version: | non sterile |
| Group packaging: | - |
| Shipping packaging: | 12 pcs/carton 960 pcs/pallet |



Description:
transparent blue

Urodynamic sets

The sets are disposable accessory for urodynamic UROMIC apparatus and intended for connection to urological catheter and for controlled filling of bladder by physiological solution for urodynamic measurements. Urodynamic set USM-S is designated for the urodynamic system UROMIC SAMBA.

Small urodynamic set USM

| | |
|----------------------|-----------------------------------|
| Product No.: | V606481-ND |
| Name (abbreviation): | Small urodynamic set USM |
| Version: | Sterile-EO |
| Group packaging: | - |
| Shipping packaging: | 150 pcs/carton 2.700 pcs/pallet |



Single use medical device intended as accessory to UROMIC apparatus during urodynamic measurements.

Small urodynamic set USM-S

| | |
|----------------------|-----------------------------------|
| Product No.: | V606481-03ND |
| Name (abbreviation): | Small urodynamic set USM-S |
| Version: | Sterile-EO |
| Group packaging: | - |
| Shipping packaging: | 150 pcs/carton 2.700 pcs/pallet |

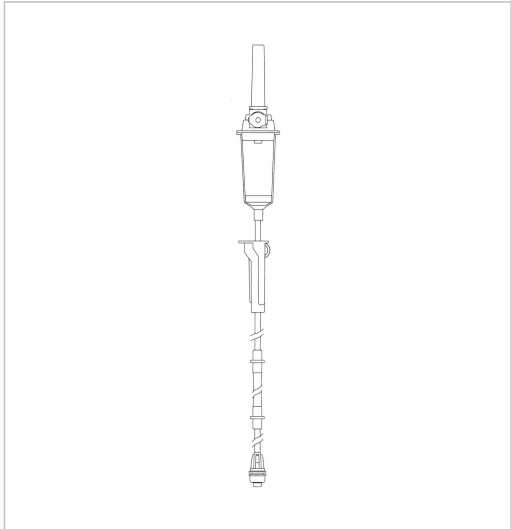

Single use medical device intended as accessory to UROMIC apparatus during urodynamic measurements.

Catheters

Neonatal catheters

The catheters for low birth weight neonates CN-01 universal are used for neonates up to 1.8 kg weight and they can be used as nurturing ones or for connection of transfusion and infusion sets when introducing them to umbilical vein. The catheters for neonates CP-01 are used for connection of infusion and transfusion set when introducing it to umbilical vein. The catheters for nutrition of neonates CV-01 are intended for artificial nutrition.

CV-01

| | |
|----------------------|-----------------------------------|
| Product No.: | V646957-ND |
| Name (abbreviation): | CV-01 |
| Version: | Sterile-EO |
| Group packaging: | 10 pack x 40 pcs |
| Shipping packaging: | 400 pcs/carton 9.600 pcs/pallet |



→ DOP freeline

Description:

PVC transparent tube 1.9/2.9 mm with scale, length 350 mm, central opening + 2 side openings, one rounded catheter end, second terminated with negative connector and cap

Neonatal nutrition catheter CV-01 – single use medical device intended for enteral feeding of newborns.

CP-01

| | |
|----------------------|-----------------------------------|
| Product No.: | V646958-ND |
| Name (abbreviation): | CP-01 |
| Version: | Sterile-EO |
| Group packaging: | 10 pack x 40 pcs |
| Shipping packaging: | 400 pcs/carton 9.600 pcs/pallet |

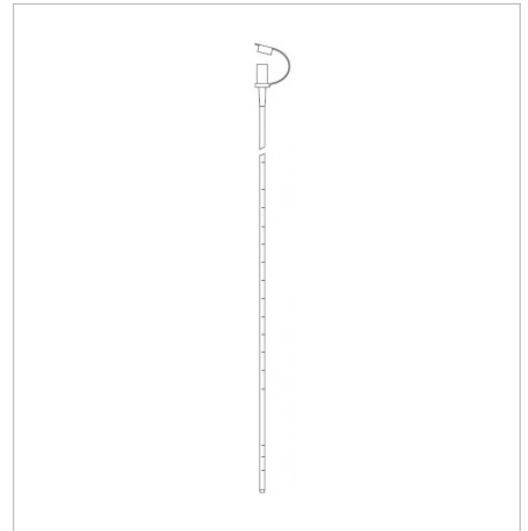

Description:

PVC transparent tube 1.9/2.9 mm with scale, length 350 mm, central opening, one rounded catheter end, second terminated with negative connector and cap

Neonatal umbilical catheter CP-01– single use medical device intended for short-term administration of infusions or for the application of drugs into the umbilical vein of a newborn.

CN-01

| | |
|----------------------|-----------------------------------|
| Product No.: | V646959-ND |
| Name (abbreviation): | CN-01 |
| Version: | Sterile-EO |
| Group packaging: | 10 pack x 40 pcs |
| Shipping packaging: | 400 pcs/carton 9.600 pcs/pallet |



Description:

PVC transparent tube 0.9/1.6 mm with scale, length 350 mm, central opening + 1 side opening, one rounded catheter end, second terminated with negative connector and cap

Catheter for neonates of low birth weight CN-01- is a universal catheter intended for newborns with low birth weight and allows use both for enteral nutrition and for infusions and application of medicine into the umbilical vein. It is a single use medical device.

CN-01 100 cm

| | |
|----------------------|-----------------------------------|
| Product No.: | V686417-01ND |
| Name (abbreviation): | CN-01 100 cm |
| Version: | Sterile-EO |
| Group packaging: | - |
| Shipping packaging: | 100 pcs/carton 6.000 pcs/pallet |



Description:

PVC transparent tube 0.9/1.6 mm with scale, length 100 mm, central opening + 1 side opening, one rounded catheter end, second terminated with negative connector and cap

Catheter for neonates CN-01 100 cm- is a disposable medical device that is used to feed a neonates who is breastfed but temporarily receives less milk from the breast than he needs. Allows the neonates to suck breast milk from the mother's breast and at the same time feed from a baby bottle or syringe.

Nasal oxygen introduction catheters

The Nasal oxygen introduction catheters are used for oxygen therapy of adults and older kids. These are connecting tubes 3.0/4.2 mm of required length, T-piece, nose terminal, terminal end, and catheter holder.

CK-472

| | |
|----------------------|----------------------------------|
| Product No.: | V646956-ND |
| Name (abbreviation): | CK-472 |
| Version: | Sterile-EO |
| Group packaging: | - |
| Shipping packaging: | 40 pcs/carton 2.400 pcs/pallet |



Description:

Connecting tubes 3.0/4.2 mm of required length, T-piece, nose terminal, terminal end, catheter holder

Single use medical device intended for oxygen introduction during the therapy for adults and adolescents.

Rectal catheters

The rectal catheters are used for examination of rectum, administration of medicines and rectal drainage. The catheters have PVC tube. One end of the catheter has central opening and the other has colour plug.

Intended use

Single use medical device intended for rectum examination, drug administration and rectal drainage.

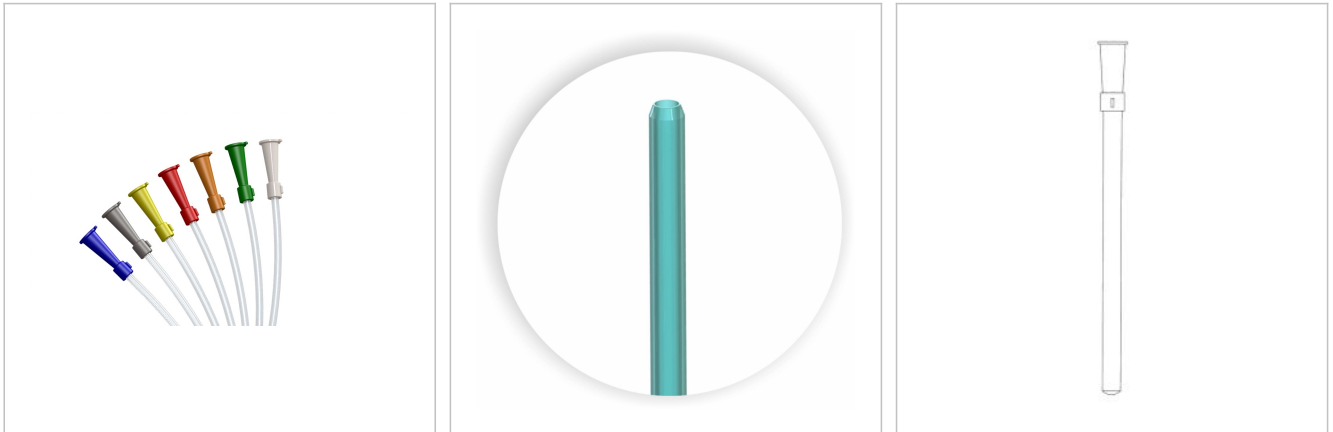

| Product No. | Name | Version | Note |
|-------------|---|------------|----------------------------|
| V646685-ND | Rectal catheter with CO, 6.67 mm (Ch 20) x 150 mm | Sterile-EO | terminal colour yellow |
| | Group pack.: 5 pack x 20 pcs Ship. pack.: 100 pcs/carton□/ 3.600 pcs/pallet | | |
| V646686-ND | Rectal catheter with CO, 6.67 mm (Ch 20) x 200 mm | Sterile-EO | terminal colour yellow |
| | Group pack.: 5 pack x 20 pcs Ship. pack.: 100 pcs/carton□/ 3.600 pcs/pallet | | |
| V646687-ND | Rectal catheter with CO, 6.67 mm (Ch 20) x 300 mm | Sterile-EO | terminal colour yellow |
| | Group pack.: 5 pack x 20 pcs Ship. pack.: 100 pcs/carton□/ 2.400 pcs/pallet | | |
| V646688-ND | Rectal catheter with CO, 6.67 mm (Ch 20) x 400 mm | Sterile-EO | terminal colour yellow |
| | Group pack.: 5 pack x 20 pcs Ship. pack.: 100 pcs/carton□/ 2.400 pcs/pallet | | |
| V646696-ND | Rectal catheter with CO, 10 mm (Ch 30) x 200 mm | Sterile-EO | terminal colour dark grey |
| | Group pack.: 5 pack x 20 pcs Ship. pack.: 100 pcs/carton□/ 3.600 pcs/pallet | | |
| V646697-ND | Rectal catheter with CO, 10 mm (Ch 30) x 300 mm | Sterile-EO | terminal colour dark grey |
| | Group pack.: 5 pack x 20 pcs Ship. pack.: 100 pcs/carton□/ 2.400 pcs/pallet | | |
| V646698-ND | Rectal catheter with CO, 10 mm (Ch 30) x 400 mm | Sterile-EO | terminal colour dark grey |
| | Group pack.: 5 pack x 20 pcs Ship. pack.: 100 pcs/carton□/ 2.400 pcs/pallet | | |
| V646699-ND | Rectal catheter with CO, 4 mm (Ch 12) x 120 mm | Sterile-EO | terminal colour white |
| | Group pack.: 5 pack x 20 pcs Ship. pack.: 100 pcs/carton□/ 3.600 pcs/pallet | | |
| V646700-ND | Rectal catheter with CO, 4.67 mm (Ch 14) x 120 mm | Sterile-EO | terminal colour dark green |
| | Group pack.: 5 pack x 20 pcs Ship. pack.: 100 pcs/carton□/ 3.600 pcs/pallet | | |
| V646701-ND | Rectal catheter with CO, 5.33 mm (Ch 16) x 120 mm | Sterile-EO | terminal colour orange |
| | Group pack.: 5 pack x 20 pcs Ship. pack.: 100 pcs/carton□/ 3.600 pcs/pallet | | |
| V646702-ND | Rectal catheter with CO, 6 mm (Ch 18) x 120 mm | Sterile-EO | terminal colour red |
| | Group pack.: 5 pack x 20 pcs Ship. pack.: 100 pcs/carton□/ 3.600 pcs/pallet | | |

| Product No. | Name | Version | Note |
|-------------|--|------------|----------------------|
| V646703-ND | Rectal catheter with CO, 8.3 mm (Ch 25) x 150 mm | Sterile-EO | terminal colour blue |
| | Group pack.: 5 pack x 20 pcs Ship. pack.: 100 pcs/carton □/ 3.600 pcs/pallet | | |
| V646704-ND | Rectal catheter with CO, 8.3 mm (Ch 25) x 200 mm | Sterile-EO | terminal colour blue |
| | Group pack.: 5 pack x 20 pcs Ship. pack.: 100 pcs/carton □/ 3.600 pcs/pallet | | |
| V646705-ND | Rectal catheter with CO, 8.3 mm(Ch 25) x 300 mm | Sterile-EO | terminal colour blue |
| | Group pack.: 5 pack x 20 pcs Ship. pack.: 100 pcs/carton □/ 2.400 pcs/pallet | | |
| V646706-ND | Rectal catheter with CO, 8.3 mm (Ch 25) x 400 mm | Sterile-EO | terminal colour blue |
| | Group pack.: 5 pack x 20 pcs Ship. pack.: 100 pcs/carton □/ 2.400 pcs/pallet | | |

Suction catheters

The catheter is intended for tracheal-bronchial suction from lungs. Flexible tube is used for being introduced in airways in order to remove foreign material by suction.



| Product No. | Name | Version | Note |
|-------------|--|------------|-----------------------------|
| V606452-ND | Endobronchial catheter CE-600 | Sterile-EO | terminal colour white |
| | Ship. pack.: 150 pcs/carton □/ 5.400 pcs/pallet | | |
| V646738-ND | Suction catheter with CO, 1 BO, 2 mm (Ch 6) x 400 mm | Sterile-EO | terminal colour light green |
| | Group pack.: 5 pack x 20 pcs Ship. pack.: 100 pcs/carton □/ 2.400 pcs/pallet | | |
| V646739-ND | Suction catheter with CO, 1 BO, 2.67 mm (Ch 8) x 400 mm | Sterile-EO | terminal colour blue |
| | Group pack.: 5 pack x 20 pcs Ship. pack.: 100 ks/karton □/ 2400 ks/paleta | | |
| V646740-ND | Suction catheter with CO, 1 BO, 3.33 mm (Ch 10) x 400 mm | Sterile-EO | terminal colour black |
| | Group pack.: 5 pack x 20 pcs Ship. pack.: 100 pcs/carton □/ 2.400 pcs/pallet | | |
| V646741-ND | Suction catheter with CO, 1 BO, 4 mm (Ch 12) x 400 mm | Sterile-EO | terminal colour white |
| | Group pack.: 5 pack x 20 pcs Ship. pack.: 100 pcs/carton □/ 2.400 pcs/pallet | | |
| V646742-ND | Suction catheter with CO, 1 BO, 4.67 mm (Ch 14) x 400 mm | Sterile-EO | terminal colour dark green |
| | Group pack.: 5 pack x 20 pcs Ship. pack.: 100 pcs/carton □/ 2.400 pcs/pallet | | |
| V646743-ND | Suction catheter with CO, 1 BO, 5.33 mm (Ch 16) x 400 mm | Sterile-EO | terminal colour orange |
| | Group pack.: 5 pack x 20 pcs Ship. pack.: 100 pcs/carton □/ 2.400 pcs/pallet | | |
| V646744-ND | Suction catheter with CO, 1 BO, 6 mm (Ch 18) x 400 mm | Sterile-EO | terminal colour red |
| | Group pack.: 5 pack x 20 pcs Ship. pack.: 100 pcs/carton □/ 2.400 pcs/pallet | | |
| V646745-ND | Suction catheter with CO, 1 BO, 6.67 mm (Ch 20) x 400 mm | Sterile-EO | terminal colour yellow |
| | Group pack.: 5 pack x 20 pcs Ship. pack.: 100 pcs/carton □/ 2.400 pcs/pallet | | |

Nasal aspirators

Nasal aspirators

The nasal aspirators are intended for children under 3 years who don't know how to clean their noses. They are used for removal of excessive phlegm from infant's nasal cavity that may result in cough or inflammation of the middle ear.

Nasal aspirator - pink

| | |
|----------------------|-----------------------------------|
| Product No.: | V626120-01ND |
| Name (abbreviation): | Nasal aspirator - pink |
| Version: | non sterile |
| Group packaging: | - |
| Shipping packaging: | 100 pcs/carton 3.000 pcs/pallet |



Description:

A transparent container with a lid (10 ml), 4.0/6.0 mm PVC tube with mouth piece, 4.0/6.0 mm PVC tube with a nasal tip.

The nasal aspirator is intended for children under the age of 3 who cannot blow their nose on their own. It is used to suck out excess mucus from the child's nasal cavity, which can cause coughing or ear infections. In the case of Nasal aspirator - pink, it is a manual type of aspirator, which is based on the principle of negative pressure created by mouth suction.

Note:

The tube with the nasal tip is to be held at the baby's nose; the user has the mouth piece in his/her mouth, sucking the mucus out. The mucus removed is retained in the container. It is a manual type of extractor, working on the underpressure principle.

Advantages

- complete production in the Czech Republic
- from health-conscious materials produced without exception in the EU!
- does not contain any glass parts
- non-toxic
- equipped with a safety nasal tip which cannot be inserted deeper into the nose and therefore the mucosa cannot be injured
- certified as a CE marked medical device
- ideal for walks and journeys where it is not possible to use the extractor with vacuum cleaner adapter and electricity
- no noise during the extraction, contrary to the extractor with vacuum cleaner adapter
- optimum length and diameter of the tubes for efficient suction and cleaning

Nasal aspirator - blue

| | |
|----------------------|-----------------------------------|
| Product No.: | V626120-02ND |
| Name (abbreviation): | Nasal aspirator - blue |
| Version: | non sterile |
| Group packaging: | - |
| Shipping packaging: | 100 pcs/carton 3.000 pcs/pallet |



Description:

A transparent container with a lid (10 ml), 4.0/6.0 mm PVC tube with mouth piece, 4.0/6.0 mm PVC tube with a nasal tip.

The nasal aspirator is intended for children under the age of 3 who cannot blow their nose on their own. It is used to suck out excess mucus from the child's nasal cavity, which can cause coughing or ear infections. In the case of Nasal aspirator - blue, it is a manual type of aspirator, which is based on the principle of negative pressure created by mouth suction.

Note:

The tube with nasal tip is to be held at the baby's nose; the user has the mouth piece in his/her mouth, sucking the mucus out. The mucus removed is retained in the container. It is a manual type of extractor, working on the underpressure principle.

Advantages

- complete production in the Czech Republic
- from health-conscious materials produced without exception in the EU!
- does not contain any glass parts
- non-toxic
- equipped with a safety nasal tip which cannot be inserted deeper into the nose and therefore the mucosa cannot be injured
- certified as a CE marked medical device
- ideal for walks and journeys where it is not possible to use the extractor with vacuum cleaner adapter and electricity
- no noise during the extraction, contrary to the extractor with vacuum cleaner adapter
- optimum length and diameter of the tubes for efficient suction and cleaning

Nasal aspirator with Vacuum Cleaner Adapter

| | |
|----------------------|---|
| Product No.: | V626150-ND |
| Name (abbreviation): | Nasal aspirator with Vacuum Cleaner Adapter |
| Version: | non sterile |
| Group packaging: | - |
| Shipping packaging: | 60 pcs/carton 1.440 pcs/pallet |



Description:

A transparent container with a lid (10 ml), 4.0/6.0 mm PVC tube with mouth piece, 4.0/6.0 mm PVC tube with a nasal tip, connection cone and a 900 mm tube with a vacuum cleaner connector.

The nasal aspirator is intended for children under the age of 3 who cannot blow their nose on their own. It is used to suck out excess mucus from the child's nasal cavity, which can cause coughing or ear infections. In the case of a Nasal aspirator with a Vacuum Cleaner Adapter, the vacuum generated by the vacuum cleaner is used for suction.

Note:

Extracting Using a Vacuum Cleaner - Attach the aspirator to the vacuum cleaner and place the tube with the safety nasal tip to the nostril of the baby. After turning the vacuum on, extract the mucus.

Extracting without a Vacuum Cleaner - Do not use the adapter. Hold the tube with the nasal tip at the baby's nose, hold the mouth piece in your mouth, and extract the mucus.

Advantages

- complete production in the Czech Republic
- from health-conscious materials produced without exception in the EU !
- does not contain any glass parts
- non-toxic
- equipped with a safety nasal tip which cannot be inserted deeper into the nose and therefore the mucosa cannot be injured
- certified as a CE marked medical device
- there are two ways to use the product - using the vacuum cleaner or in a standard way as a manual aspirator
- limiting contact with the infected baby and adhering to hygiene practices
- extracting the mucus with a vacuum cleaner is fast, safe and effective
- the connection to the vacuum cleaner is designed with a universal adapter suitable for all types of household vacuum cleaners with a power up to 1800 W
- optimum length and diameter of the tubes for efficient suction and cleaning

PVC tubes for medical purposes

PVC tubes for medical purposes

The tubes are used as connections between devices and tools not in contact with body liquids, as connections between devices and water or gas sources, suction with central technical suction, technical components inside devices, for removal of harmful exhaust gases from devices and environment and for repairs of devices and tools not in contact with body liquids (stethoscopes, acouphones etc.).

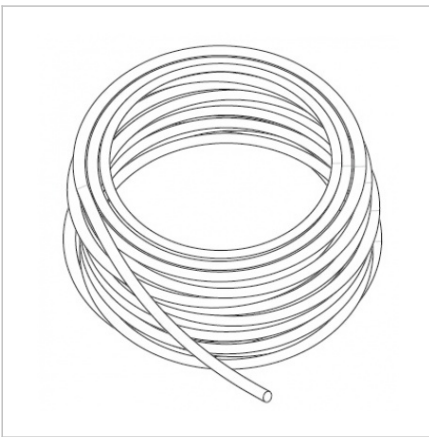

| Product No. | Name | Version | Note |
|-------------|---|-------------|------|
| V606801-ND | Tube 3.0/4.2 mm | non sterile | |
| | Group pack.: 50 m Ship. pack.: 18 pack/carton | | |
| V606802-ND | Tube 4.0/6.0 mm | non sterile | |
| | Group pack.: 50 m Ship. pack.: 6 pack/carton | | |
| V606803-ND | Tube 5.0/7.0 mm | non sterile | |
| | Group pack.: 50 m Ship. pack.: 4 pack/carton | | |
| V606804-ND | Tube 8.0/12.0 mm | non sterile | |
| | Group pack.: 20 m Ship. pack.: 4 pack/carton | | |
| V606805-ND | Tube 1.9/2.9 mm | non sterile | |
| | Group pack.: 50 m Ship. pack.: 20 pack/carton | | |
| V606806-ND | Tube 2.7/4.1 mm | non sterile | |
| | Group pack.: 50 m Ship. pack.: 18 pack/carton | | |
| V606807-ND | Tube 3.0/4.8 mm | non sterile | |
| | Group pack.: 50 m Ship. pack.: 16 pack/carton | | |
| V606809-ND | Tube 3.5/5.5 mm | non sterile | |
| | Group pack.: 50 m Ship. pack.: 12 pack/carton | | |
| V606810-ND | Tube 3.6/4.8 mm | non sterile | |
| | Group pack.: 50 m Ship. pack.: 16 pack/carton | | |
| V606811-ND | Tube 4.5/6.8 mm | non sterile | |
| | Group pack.: 50 m Ship. pack.: 4 pack/carton | | |

| Product No. | Name | Version | Note |
|-------------|--|-------------|------|
| V606812-ND | Tube 5.0/6.5 mm | non sterile | |
| | Group pack.: 50 m Ship. pack.: 10 pack/carton | | |
| V606830-ND | Tube 0.9/1.6 mm | non sterile | |
| | Group pack.: 100 m Ship. pack.: 20 pack/carton | | |
| V606832-ND | Tube 1.0/2.0 mm | non sterile | |
| | Group pack.: 100 m Ship. pack.: 20 pack/carton | | |
| V606833-ND | Tube 8.0/12.0 mm | non sterile | |
| | Group pack.: 20 m Ship. pack.: 4 pack/carton | | |

LAB laboratory aids

Petri dishes

Diameter of Petri dishes 90 mm

The Petri dishes for in vitro diagnostic are used in clinical practice for the cultivation of microorganisms, obtained from the human samples on photosensitive or solid culture media.

Petri dish 90 mm

| | |
|----------------------|--|
| Product No.: | V400900 |
| Name (abbreviation): | Petri dish 90 mm |
| Version: | Higher level of disinfection with peracetic acid |
| Group packaging: | 1 pack/20 pcs 24 pack x 20 pcs/carton |
| Shipping packaging: | 480 pcs/carton 9.600 pcs/480 pack/pallet |



Description:

Dish height 14.5 mm, dish diameter 86.5 mm, wall thickness 1 – 1,2 mm

Note:

Cultivation of micro-organisms on fixed substrate

Petri dish 90 mm NL with non-transparent lid

| | |
|----------------------|--|
| Product No.: | V400902 |
| Name (abbreviation): | Petri dish 90 mm NL with non-transparent lid |
| Version: | Higher level of disinfection with peracetic acid |
| Group packaging: | 1 pack/20 pcs 24 pack x 20 pcs/carton |
| Shipping packaging: | 480 pcs/carton 9.600 pcs/480 pack/pallet |



Description:

Dish height 14.5 mm, dish diameter 86.5 mm

Note:

Cultivation of micro-organisms in photo-sensitive bacteriological soils, non-transparent lid

Petri dish 90 mm new

| | |
|----------------------|--|
| Product No.: | V400974 |
| Name (abbreviation): | Petri dish 90 mm new |
| Version: | Higher level of disinfection with peracetic acid |
| Group packaging: | 1 pack/20 pcs 24 pack x 20 pcs/carton |
| Shipping packaging: | 480 pcs/carton 9.600 pcs/480 pack/pallet |



Description:

Dish height 14.5 mm, dish diameter 86.5 mm, wall thickness 0,65 – 0,8 mm

Note:

Cultivation of micro-organisms on fixed substrate

Petri dish 90 mm - R

| | |
|----------------------|--|
| Product No.: | V400994 |
| Name (abbreviation): | Petri dish 90 mm - R |
| Version: | Sterile-R |
| Group packaging: | 1 pack/20 pcs 15 pack x 20 pcs/carton |
| Shipping packaging: | 300 pcs/carton 7.200 pcs/360 pack/pallet |

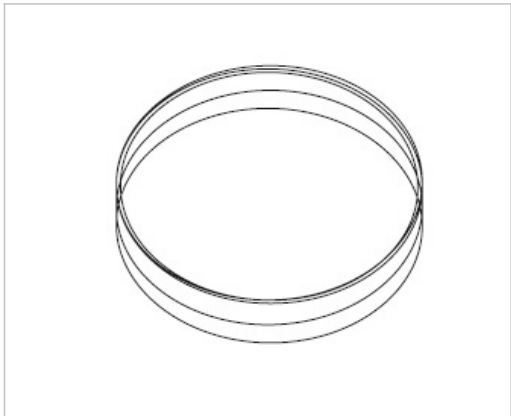

Description:

Dish height 14.5 mm, dish diameter 86.5 mm

Note:

Cultivation of micro-organisms on fixed substrate

Petri dish 90 mm - EO

| | |
|----------------------|--|
| Product No.: | V400995 |
| Name (abbreviation): | Petri dish 90 mm - EO |
| Version: | Sterile-EO |
| Group packaging: | 1 pack/20 pcs 24 pack x 20 pcs/carton |
| Shipping packaging: | 480 pcs/carton 7.200 pcs/360 pack/pallet |

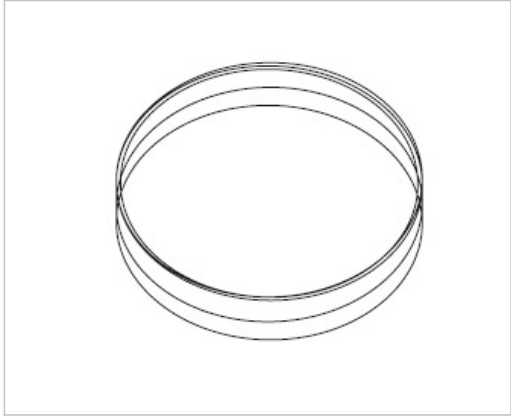

Description:

Dish height 14.5 mm, dish diameter 86.5 mm

Note:

Cultivation of micro-organisms on fixed substrate

Petri dish 90 mm AP

| | |
|----------------------|--|
| Product No.: | V204420 |
| Name (abbreviation): | Petri dish 90 mm AP |
| Version: | UV-C disinfection |
| Group packaging: | 1 pack/20 pcs 24 pack x 20 pcs/carton |
| Shipping packaging: | 480 pcs/carton 9.600 pcs/480 pack/pallet |

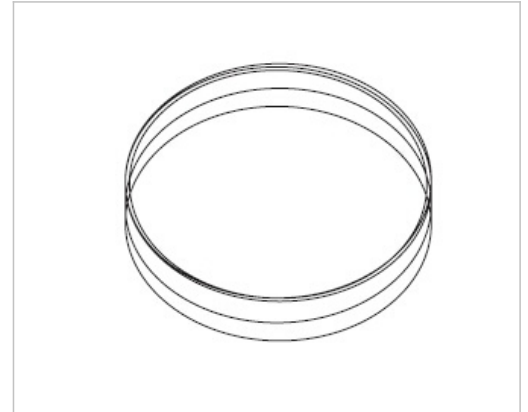

Description:

External diameter of dish 88 mm, external diameter of lid 92 mm, height of set 14 mm. Lid with triple venting protrusions.

Each batch is checked for internal sterility according Czech Pharmacopea 2017.

Note:

Petri dishes are designed for the cultivation of micro-organisms on nutrient and photosensitive bacteriological soils and tissue cultures for oncological and virological purposes.

Suitable for use in filling machines (for example APS One).The design ensures stability in stacking.Material (PS) suitable for contact with food. UV disinfection - production and packaging in hygiene space with UV-C radiation in automatic mode without direct entry of people.

Petri dish 90 mm AP 2 - compartment

| | |
|----------------------|--|
| Product No.: | V204421 |
| Name (abbreviation): | Petri dish 90 mm AP 2 - compartment |
| Version: | UV-C disinfection |
| Group packaging: | 1 pack/20 pcs 24 pack x 20 pcs/carton |
| Shipping packaging: | 480 pcs/carton 9.600 pcs/480 pack/pallet |

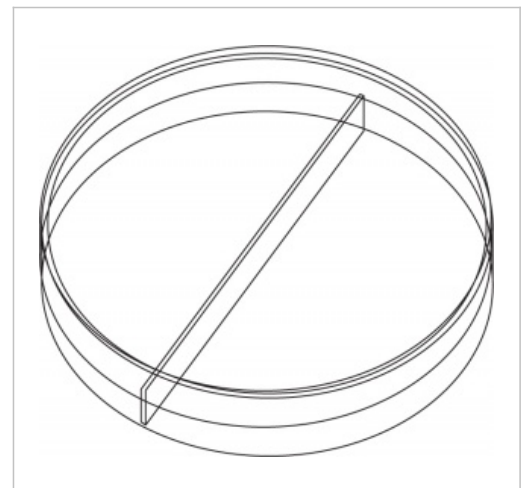

Description:

External diameter of dish 88 mm, external diameter of lid 92 mm, height of set 14 mm. Lid with triple venting protrusions. Each batch is checked for internal sterility according Czech Pharmacopea 2017.

Note:

Petri dishes are designed for the cultivation of microorganisms on nutrient and photosensitive bacteriological soils and tissue cultures for oncological and virological purposes.

The design ensures stability in stacking. Material (PS) suitable for contact with food. UV disinfection - production and packaging in hygiene space with UV-C radiation in automatic mode without direct entry of people.

Petri dish 90 mm AP 3 - compartment

| | |
|----------------------|--|
| Product No.: | V204422 |
| Name (abbreviation): | Petri dish 90 mm AP 3 - compartment |
| Version: | UV-C disinfection |
| Group packaging: | 1 pack/20 pcs 24 pack x 20 pcs/carton |
| Shipping packaging: | 480 pcs/carton 9.600 pcs/480 pack/pallet |

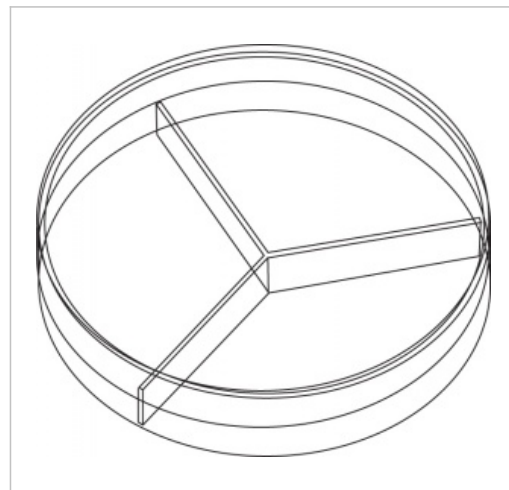

Description:

External diameter of dish 88 mm, external diameter of lid 92 mm, height of set 14 mm. Lid with triple venting protrusions. Each batch is checked for internal sterility according Czech Pharmacopea 2017.

Note:

Petri dishes are designed for the cultivation of microorganisms on nutrient and photosensitive bacteriological soils and tissue cultures for oncological and virological purposes.

The design ensures stability in stacking. Material (PS) suitable for contact with food. UV disinfection - production and packaging in hygiene space with UV-C radiation in automatic mode without direct entry of people.

Diameter of Petri dishes 60 mm

The Petri dishes for in vitro diagnostic are used in clinical practice for the cultivation of microorganisms, obtained from the human samples on photosensitive or solid culture media. The Petri dish for tissue cultures is intended for in vitro diagnostic in clinical practice for the cultivation of tissue cultures obtained from human samples.

Petri dish 60 mm

| | |
|----------------------|--|
| Product No.: | V400927 |
| Name (abbreviation): | Petri dish 60 mm |
| Version: | Higher level of disinfection with peracetic acid |
| Group packaging: | 1 pack/20 pcs 20 pack x 48 pcs/carton |
| Shipping packaging: | 960 pcs/carton 14.400 pcs/720 pack/pallet |



Description:

Dish height 13.5 mm, dish diameter 56 mm

Note:

Cultivation of micro-organisms on fixed substrate

Petri dish 60 mm - TC

| | |
|----------------------|---|
| Product No.: | V400928 |
| Name (abbreviation): | Petri dish 60 mm - TC |
| Version: | Sterile-R |
| Group packaging: | 1 pack/20 pcs 20 pack x 42 pcs/carton |
| Shipping packaging: | 840 pcs/carton 20.160 pcs/480 pack/pallet |

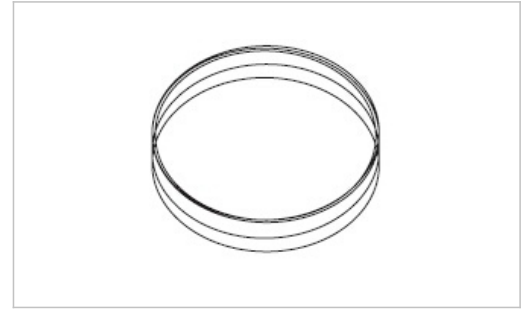

Description:

Dish height 13.5 mm, dish diameter 56 mm, hydrophilization of dish - increased surface tension value for better wettability, treated with gamma radiation.

Note:

Cultivation of tissue cultures for virological and oncological purposes

Test tubes

Test tubes 10 ccm and 15 ccm

The test tubes (unsterile) are intended for taking and storing of samples, particularly of biological material, for some laboratory tests, chemical reactions etc.

The test tubes (sterile) are intended for taking and storing of samples, transport and storage of samples of blood and other biological materials. The product is intended for in vitro diagnostic of human samples in clinical practice together with other medical device.

Test tube 10 ccm PS

| | |
|----------------------|---|
| Product No.: | V400912 |
| Name (abbreviation): | Test tube 10 ccm PS |
| Version: | non sterile |
| Group packaging: | 1 pack/20 pcs 100 pack x 2.000 pcs/karton |
| Shipping packaging: | 2.000 pcs/carton 40.000 pcs/2.000 pack/pallet |

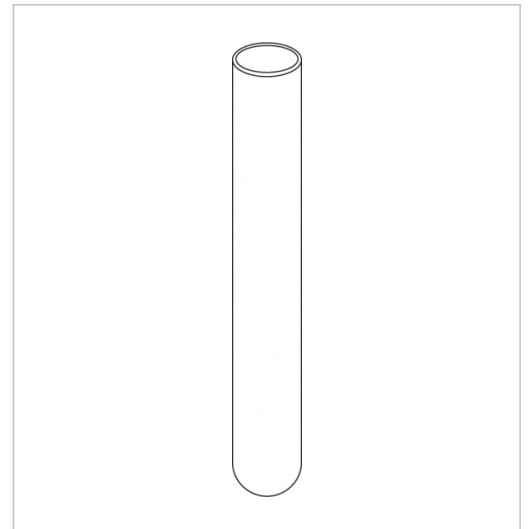

Description:

Available volume 8 ccm, PS material

Note:

Suitable plugs, which are not included, can be ordered additionally:
 V493307, V400547 blue plug, see more information Plugs for test tubes 10 ccm and 15 ccm

Test tube 10 ccm PP

| | |
|----------------------|---|
| Product No.: | V400945 |
| Name (abbreviation): | Test tube 10 ccm PP |
| Version: | non sterile |
| Group packaging: | 1 pack/20 pcs 100 pack x 2.000 pcs/karton |
| Shipping packaging: | 2.000 pcs/carton 40.000 pcs/2.000 pack/pallet |

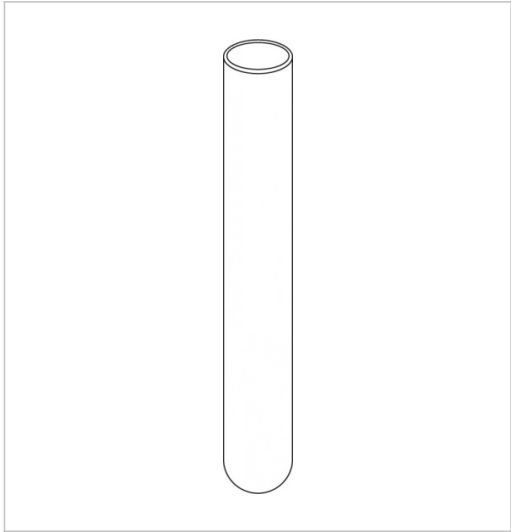

Description:

Available volume 8 ccm, PP material

Note:

Suitable plugs, which are not included, can be ordered additionally:
 V493307, V400547 blue plug, see more information Plugs for test tubes 10 ccm and 15 ccm

Test tube 10 ccm PS - sterile

| | |
|----------------------|---|
| Product No.: | V400914 |
| Name (abbreviation): | Test tube 10 ccm PS - sterile |
| Version: | Sterile-R |
| Group packaging: | 1 pack/20 pcs 70 pack x 1.400 pcs/carton |
| Shipping packaging: | 1.400 pcs/carton 25.200 pcs/1.260 pack/pallet |

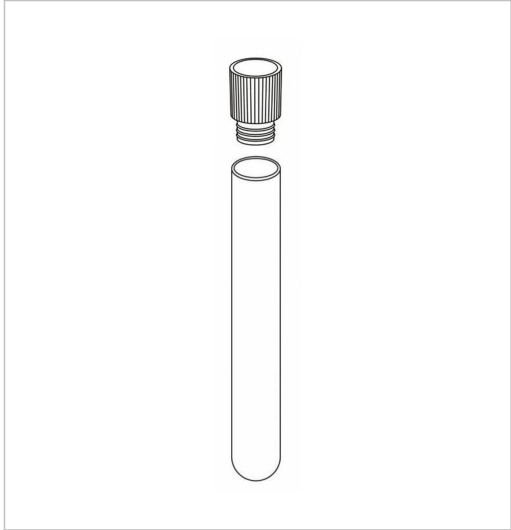

Description:

Available volume 8 ccm, PS material, blue plug

Note:

Variant of V400914-01 - version with plug V493307

Test tube 10 ccm PS - sterile without plug

| | |
|----------------------|---|
| Product No.: | V400523 |
| Name (abbreviation): | Test tube 10 ccm PS - sterile without plug |
| Version: | Sterile-R |
| Group packaging: | 1 pack/20 pcs 70 pack x 1.400 pcs/carton |
| Shipping packaging: | 1.400 pcs/carton 25.200 pcs/1.260 pack/pallet |

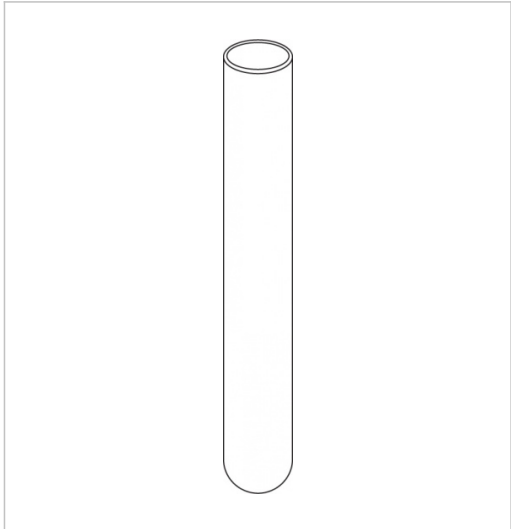

Description:

Available volume 8 ccm, PS material

Test tube 10 ccm PP - sterile

| | |
|----------------------|--|
| Product No.: | V400942 |
| Name (abbreviation): | Test tube 10 ccm PP - sterile |
| Version: | Sterile-R |
| Group packaging: | 1 pack/20 pcs 70 pack x 1.400 pcs/carton |
| Shipping packaging: | 25.200 pcs/1.260 pack/pallet |

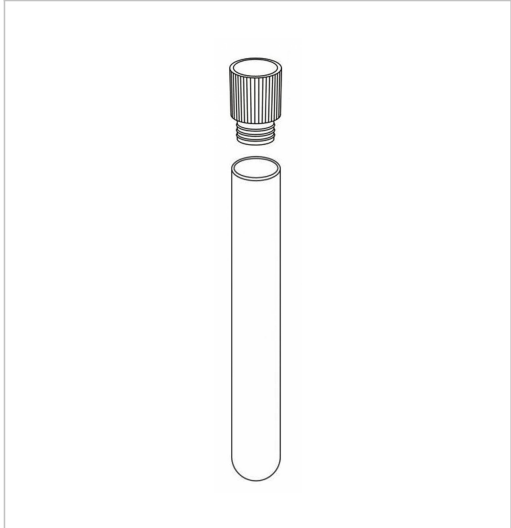

Description:

Available volume 8 ccm, PP material, blue plug is included

Test tube 15 ccm PS

| | |
|----------------------|--|
| Product No.: | V400913 |
| Name (abbreviation): | Test tube 15 ccm PS |
| Version: | non sterile |
| Group packaging: | 1 pack/20 pcs 60 pack x 1.200 pcs/karton |
| Shipping packaging: | 1.200 pack/24.000 pcs/pallet |

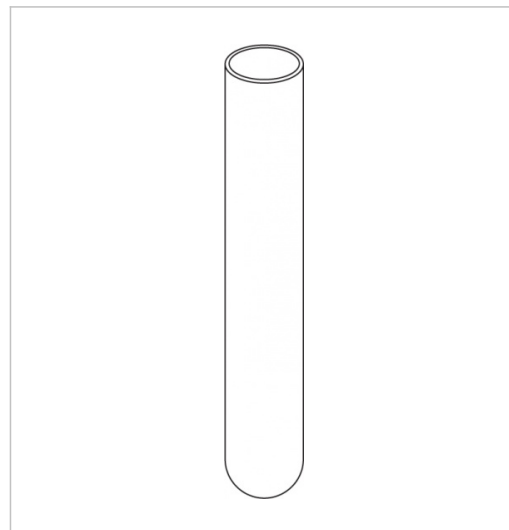

Description:

Available volume 12 ccm, PS material

Note:

Suitable plugs, which are not included, can be ordered additionally:

V400548, V493306 blue plug, to close test tubes product, see more information Plugs for test tubes 10 ccm and 15 ccm

Test tube 15 ccm PP

| | |
|----------------------|---|
| Product No.: | V400946 |
| Name (abbreviation): | Test tube 15 ccm PP |
| Version: | non sterile |
| Group packaging: | 1 pack/20 pcs 60 pack x 1.200 pcs/karton |
| Shipping packaging: | 1.200 pcs/carton 1.200 pack/24.000 pcs/pallet |

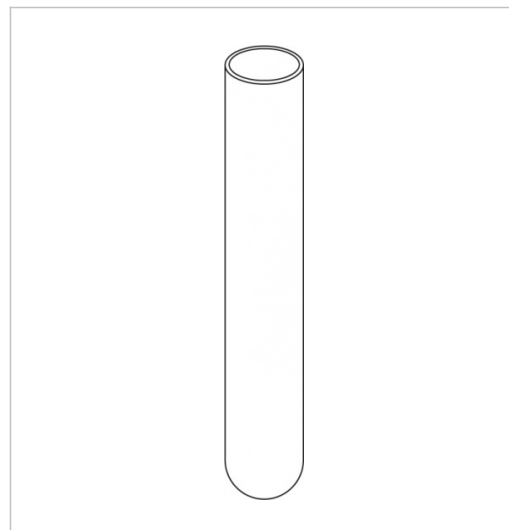

Description:

Available volume 12 ccm, PP material

Note:

Suitable plugs, which are not included, can be ordered additionally:

V400548, V493306 blue plug, to close test tubes product, see more information Plugs for test tubes 10 ccm and 15 ccm

Test tube 15 ccm PS - sterile

| | |
|----------------------|---|
| Product No.: | V400915 |
| Name (abbreviation): | Test tube 15 ccm PS - sterile |
| Version: | Sterile-R |
| Group packaging: | 1 pack/20 pcs 60 pack x 1.200 pcs/karton |
| Shipping packaging: | 1200 ks/carton 1.080 pack/21.600 pcs/pallet |

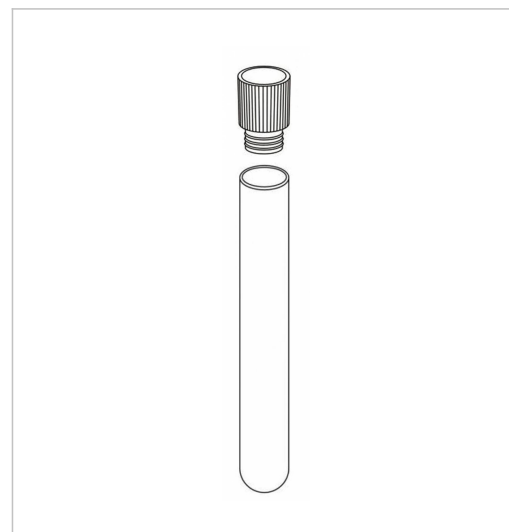

Description:

Available volume 12 ccm, PS material, including the plug (NEW)

Note:

Variant of V400915-01 - version with plug V493306

Test tube 15 ccm PP - sterile

| | |
|----------------------|--|
| Product No.: | V400941 |
| Name (abbreviation): | Test tube 15 ccm PP - sterile |
| Version: | Sterile-R |
| Group packaging: | 1 pack/20 pcs 60 pack x 1.200 pcs/karton |
| Shipping packaging: | 1.200 ks/carton 1.080 pack/21.600 pcs/pallet |

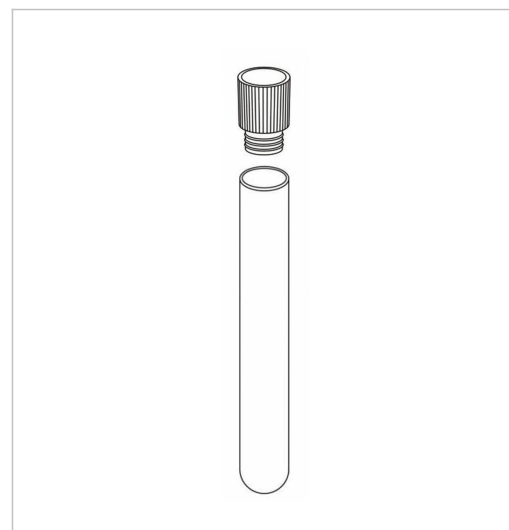

Description:

Available volume 12 ccm, PP material, blue plug is included

Test tube 15 ccm PS - sterile without plug

| | |
|----------------------|---|
| Product No.: | V400526 |
| Name (abbreviation): | Test tube 15 ccm PS - sterile without plug |
| Version: | Sterile-R |
| Group packaging: | 1 pack/20 pcs 60 pack x 1.200 pcs/carton |
| Shipping packaging: | 1.080 pcs/carton 21.600 pcs/1.080 pack/pallet |

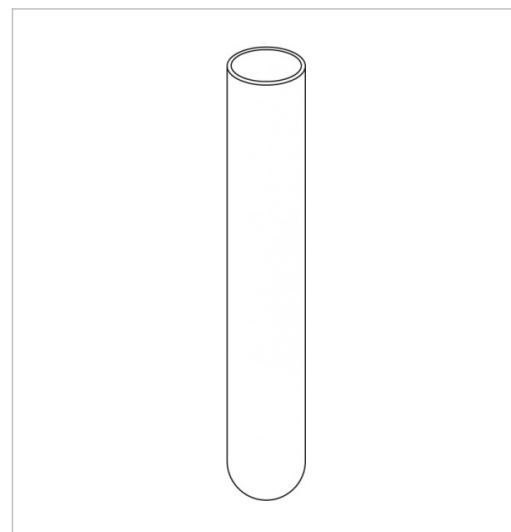

Description:

Available volume 12 ccm, PS material

Plugs for test tubes 10 ccm and 15 ccm

The plugs are used for tight closure of plastic test tubes.

Plug for test tubes of 10 ccm

| | |
|----------------------|-------------------------------|
| Product No.: | V493307 |
| Name (abbreviation): | Plug for test tubes of 10 ccm |
| Version: | non sterile |
| Group packaging: | 100 pcs |
| Shipping packaging: | 1000 pcs |



Description:

PE material, blue colour

Note:

493307-53 yellow plug, 493307-54 green plug, to close test tubes product No. 400912 and product No. 400945

Test tube plug 10 ccm N

| | |
|----------------------|-------------------------|
| Product No.: | V400547 |
| Name (abbreviation): | Test tube plug 10 ccm N |
| Version: | non sterile |
| Group packaging: | 100 pcs |
| Shipping packaging: | 1000 pcs |

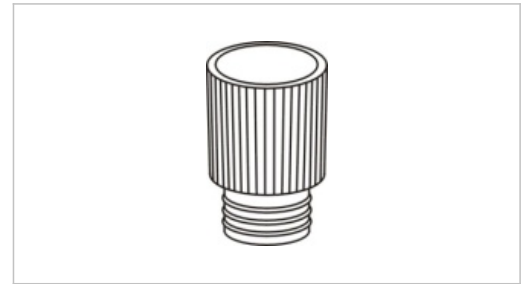

Description:

PE material, blue colour

Note:

To close test tubes product No. 400912 and 400945

Plug for test tubes of 15 ccm

| | |
|----------------------|-------------------------------|
| Product No.: | V493306 |
| Name (abbreviation): | Plug for test tubes of 15 ccm |
| Version: | non sterile |
| Group packaging: | 100 pcs |
| Shipping packaging: | 1000 pcs |

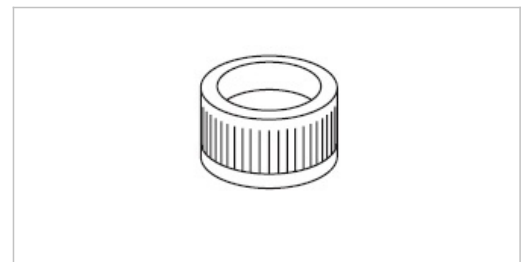

Description:

PE material, blue colour

Note:

To close test tubes product No. 400913 and 400946.

Test tube plug 15 ccm N

| | |
|----------------------|-------------------------|
| Product No.: | V400548 |
| Name (abbreviation): | Test tube plug 15 ccm N |
| Version: | non sterile |
| Group packaging: | 100 pcs |
| Shipping packaging: | 1000 pcs |



Description:

PE material, blue colour

Note:

To close test tubes product No. 400913 and 400946.

Microtitration plates and other

Microtitration plate U and P

The micro-titration plates U and P unsterile are intended for diagnostic examinations in laboratories.

The micro-titration plates U a P are intended for perform of series diagnostic examinations in vitro diagnostic.

Microtitration plate P - non sterile

| | |
|----------------------|--|
| Product No.: | V400954 |
| Name (abbreviation): | Microtitration plate P - non sterile |
| Version: | non sterile |
| Group packaging: | 1 pack/10 pcs 24 pack x 240 pcs/karton |
| Shipping packaging: | 240 pcs/carton 4.800 pcs/480 pack/pallet |

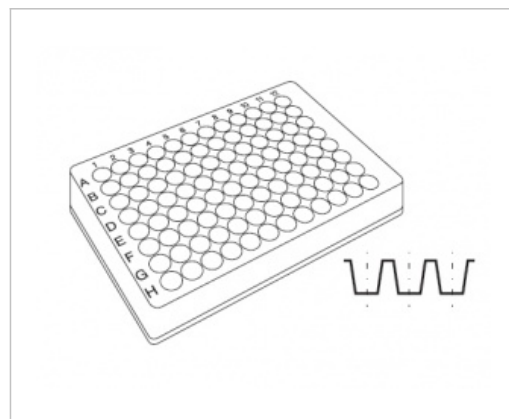

Description:

Bottom shape - flat, clear PS, 96 holes (8 rows and 12 holes each), identified by numbers and letters, dimension 86 x 128 mm, height with lid 18 mm, They're sold without a lid.

Note:

hole diameter 7 mm, depth 9.7 mm

Microtitration plate P

| | |
|----------------------|--|
| Product No.: | V400917 |
| Name (abbreviation): | Microtitration plate P |
| Version: | Higher level of disinfection with peracetic acid |
| Group packaging: | 1 pack/10 pcs 24 pack x 240 pcs/karton |
| Shipping packaging: | 240 pcs/carton 4.800 pcs/480 pack/pallet |

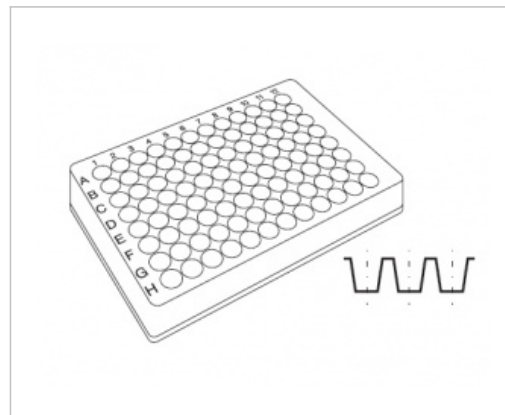

Description:

Bottom shape - flat, clear PS, 96 holes (8 rows and 12 holes each), identified by numbers and letters, dimension 86 x 128 mm, height with lid 18 mm
 They're sold without a lid.

Note:

hole diameter 7 mm, depth 9.7 mm
 Volume 0,3 ml

Microtitration plate U

| | |
|----------------------|--|
| Product No.: | V400916 |
| Name (abbreviation): | Microtitration plate U |
| Version: | Higher level of disinfection with peracetic acid |
| Group packaging: | 1 pack/10 pcs 24 pack x 240 pcs/karton |
| Shipping packaging: | 240 pcs/carton 4.800 pcs/480 pack/pallet |

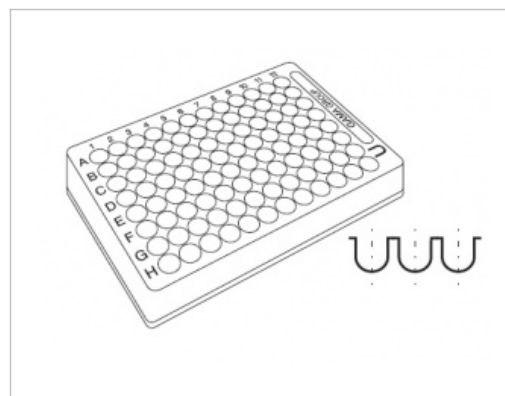

Description:

Bottom shape - round, clear PS, 96 holes (8 rows and 12 holes each), identified by numbers and letters, dimension 86 x 128 mm, height with lid 18 mm.

Note:

hole diameter 7 mm, depth 9.7 mm

Microtitration plate U - non sterile

| | |
|----------------------|--|
| Product No.: | V400953 |
| Name (abbreviation): | Microtitration plate U - non sterile |
| Version: | non sterile |
| Group packaging: | 1 pack/10 pcs 24 pack x 240 pcs/karton |
| Shipping packaging: | 240 pcs/carton 4.800 pcs/480 pack/pallet |

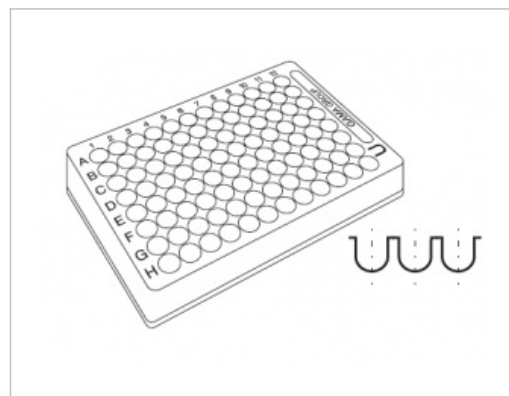

Description:

Bottom shape - round, clear PS, 96 holes (8 rows and 12 holes each), identified by numbers and letters, dimension 86 x 128 mm, height with lid 18 mm.

Note:

hole diameter 7 mm, depth 9.7 mm

Lid of the microtitration plate

| | |
|----------------------|--|
| Product No.: | V400921 |
| Name (abbreviation): | Lid of the microtitration plate |
| Version: | non sterile |
| Group packaging: | 5 pcs 20 pack x 100 pcs/karton |
| Shipping packaging: | 100 pcs/carton 4.200 pcs/840 pack/pallet |

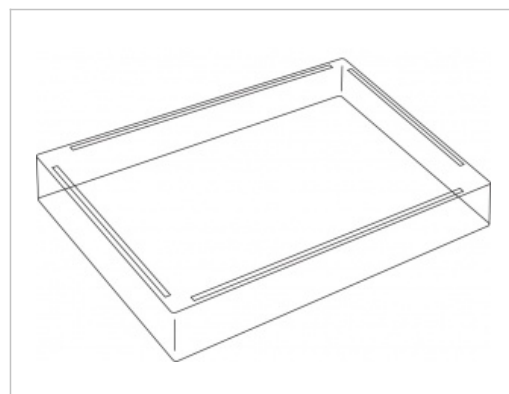

Description:

Clear PS material

Note:

Used for covering of MTD U, MTD P and MTD P divided

Microtitration plate 6sectors - culture

| | |
|----------------------|--|
| Product No.: | V400556 |
| Name (abbreviation): | Microtitration plate 6sectors - culture |
| Version: | Higher level of disinfection with peracetic acid |
| Group packaging: | 1 pack/10 pcs 22 pack x 220 pcs/karton |
| Shipping packaging: | 220 pcs/carton 5.280 pcs/528 pack/pallet |



Description:

Full set - lid and plate, 6 equally big sectors 34 x 34 mm, plate dimension 85 x 127, height with lid 18 mm

Note:

Cultivation of micro-organisms on fixed substrate

Lid of the microtitration plate – disinfected

| | |
|----------------------|--|
| Product No.: | V400921-01 |
| Name (abbreviation): | Lid of the microtitration plate – disinfected |
| Version: | Higher level of disinfection with peracetic acid |
| Group packaging: | 5 pcs 20 pack x 100 pcs/karton |
| Shipping packaging: | 100 pcs/carton 4.200 pcs/840 pack/pallet |

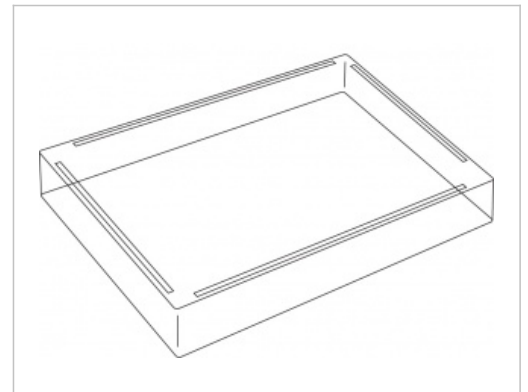

Description:

Clear PS material

Note:

Used for covering of MTD U, MTD P and MTD P divided

Terasaki microtitration plates

Terasaki micro-titration plate is intended for in vitro diagnostic for tests of antigens and antidotes in a cytotoxic way.

Terasaki microtitration plate

| | |
|----------------------|--|
| Product No.: | V400919 |
| Name (abbreviation): | Terasaki microtitration plate |
| Version: | non sterile |
| Group packaging: | 1 pack/10 pcs 20 pack x 200 pcs/carton |
| Shipping packaging: | 200 pcs/carton 8.400 pcs/840 pack/pallet |

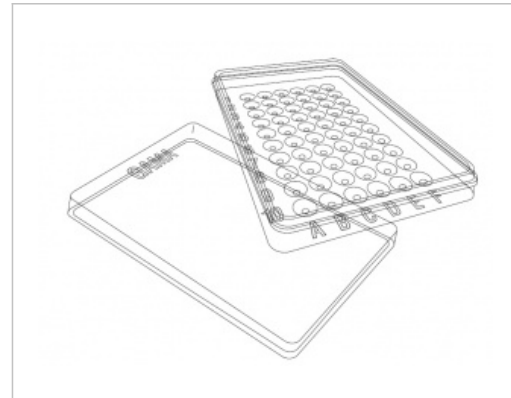

Description:

60 cone-shaped holes, bottom diameter 1 mm, identified with letters and numbers, plate + lid - clear PS material

Note:

Inner surface of the plate is hydrophilized, V(hole) 0,012 ml

Microtitration plates P divided

The divided micro-titration plates intended for in vitro diagnostic are used for series diagnostic examinations in laboratories for serological purposes. With the ability to sort individual strips of detection holes in the required quantity and sequence these products can be used in the examination of low volume samples. The inlays are intended for separate assembly of MTD divided by P directly by the user. However, we recommend complete MTD sets divided by P.

Divided inlays of P type - triple strip

| | |
|----------------------|---|
| Product No.: | V400939 |
| Name (abbreviation): | Divided inlays of P type - triple strip |
| Version: | non sterile |
| Group packaging: | 1 pack/20 pcs 50 pack x 1.000 pcs/carton |
| Shipping packaging: | 1.000 pcs/carton 20.000 pcs/1.000 pack/pallet |



Description:

24 holes P, PS material clear

Divided inlays of P type - double strip

| | |
|----------------------|---|
| Product No.: | V400938 |
| Name (abbreviation): | Divided inlays of P type - double strip |
| Version: | non sterile |
| Group packaging: | 1 pack/30 pcs 50 pack x 1.500 pcs/carton |
| Shipping packaging: | 1.500 pcs/carton 30.000 pcs/1.000 pack/pallet |



Description:
16 holes P, PS material clear

Divided inlays of P type - single strip

| | |
|----------------------|---|
| Product No.: | V400937 |
| Name (abbreviation): | Divided inlays of P type - single strip |
| Version: | non sterile |
| Group packaging: | 1 pack/60 pcs 50 pack x 3.000 pcs/carton |
| Shipping packaging: | 3.000 pcs/carton 60.000 pcs/360 pack/pallet |

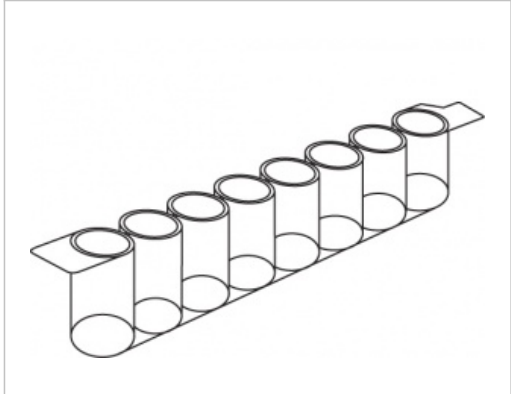

Description:
8 holes P, PS material clear

Microtitration plate - divided of P type - triple strip

| | |
|----------------------|---|
| Product No.: | V400936 |
| Name (abbreviation): | Microtitration plate - divided of P type - triple strip |
| Version: | non sterile |
| Group packaging: | 1 pack/5 pcs 48 pack x 240 pcs/carton |
| Shipping packaging: | 240 pcs/carton 4.800 pcs/960 pack/pallet |

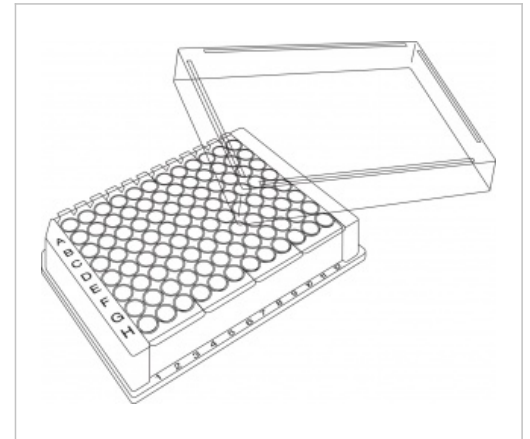

Description:

Lid, frame, 4 inserts

Microtitration plate - divided of P type - double strip

| | |
|----------------------|---|
| Product No.: | V400935 |
| Name (abbreviation): | Microtitration plate - divided of P type - double strip |
| Version: | non sterile |
| Group packaging: | 1 pack/5 pcs 48 pack x 240 pcs/carton |
| Shipping packaging: | 240 pcs/carton 4.800 pcs/960 pack/pallet |

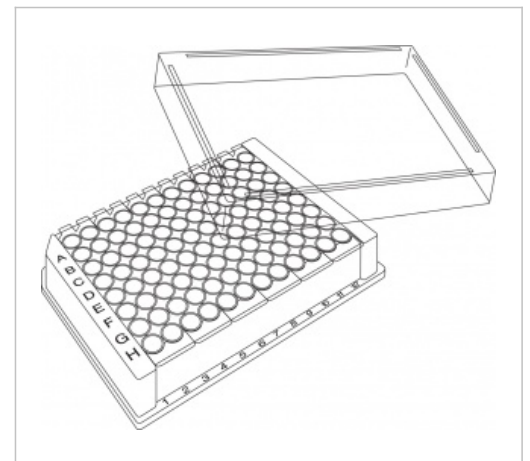

Description:

Lid, frame, 6 inserts

Microtitration plate - divided of P type - single strip

| | |
|----------------------|---|
| Product No.: | V400933 |
| Name (abbreviation): | Microtitration plate - divided of P type - single strip |
| Version: | non sterile |
| Group packaging: | 1 pack/5 pcs 48 pack x 240 pcs/carton |
| Shipping packaging: | 240 pcs/carton 4.800 pcs/960 pack/pallet |



Description:

Lid, frame, 12 inserts

Pasteur pipettes

Pasteur pipettes

The Pasteur pipettes are used particularly in bio-chemical, chemical and micro-biological laboratories for temperatures up to 70°C. They may not be used for oxidizing chemicals. All types of pipettes are produced from clear LDPE, they can be also delivered in different colour depending on customer requirements.

Pipette 190

| | |
|----------------------|--|
| Product No.: | V204500 |
| Name (abbreviation): | Pipette 190 |
| Version: | non sterile |
| Group packaging: | 1 pack/250 pcs 10 pack x 2500 pcs/carton |
| Shipping packaging: | 2500 pcs/carton 37.500 pcs/150 pack/pallet |

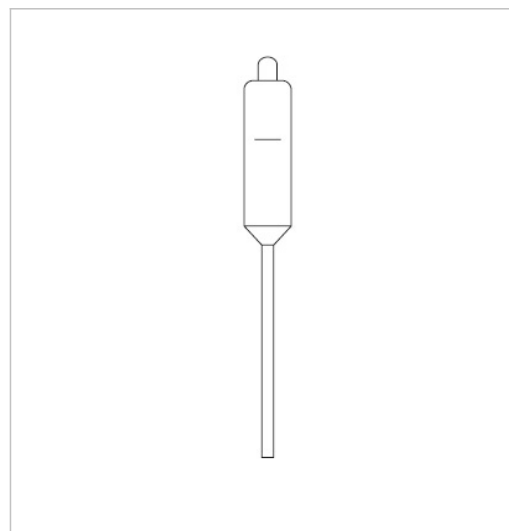

Description:

Flask volume: 15 ml
 Pipette length : 168-171 mm
 Drops per 1 ml: 17 ± 2
 Scale: no

Note:

big flask

Pipette 195

| | |
|----------------------|--|
| Product No.: | V204501 |
| Name (abbreviation): | Pipette 195 |
| Version: | non sterile |
| Group packaging: | 1 pack./100 pcs 10 pack. x 1.000 pcs/carton |
| Shipping packaging: | 1.000 pcs/carton 15.000 pcs/150 pack./pallet |



Description:

Flask volume: 15 ml
 Pipette length : 300-303 mm
 Drops per 1 ml: 25 ± 3
 Scale: no

Note:

extra long, big flask

Pipette 202

| | |
|----------------------|--|
| Product No.: | V204502 |
| Name (abbreviation): | Pipette 202 |
| Version: | non sterile |
| Group packaging: | 1 pack./500 pcs 10 pack. x 5.000 pcs/carton |
| Shipping packaging: | 5.000 pcs/carton 75.000 pcs/150 pack./pallet |

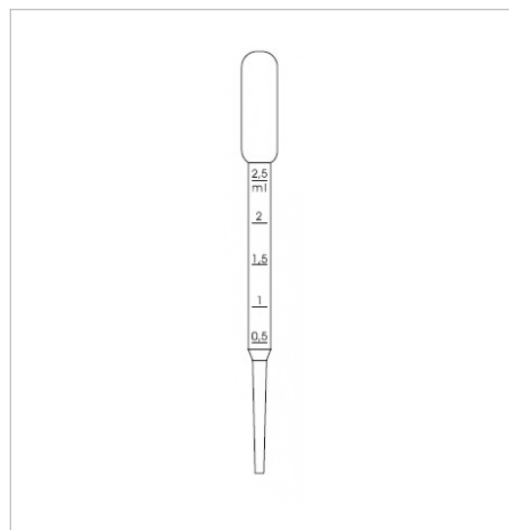

Description:

Flask volume: 4 ml
 Pipette length : 151-154 mm
 Drops per 1 ml: 25 ± 3
 Scale:yes, up to 2,5 ml

Note:

standard flask

Pipette 203

| | |
|----------------------|--|
| Product No.: | V204503 |
| Name (abbreviation): | Pipette 203 |
| Version: | non sterile |
| Group packaging: | 1 pack./500 pcs 10 pack. x 5.000 pcs/carton |
| Shipping packaging: | 5.000 pcs/carton 75.000 pcs/150 pack./pallet |

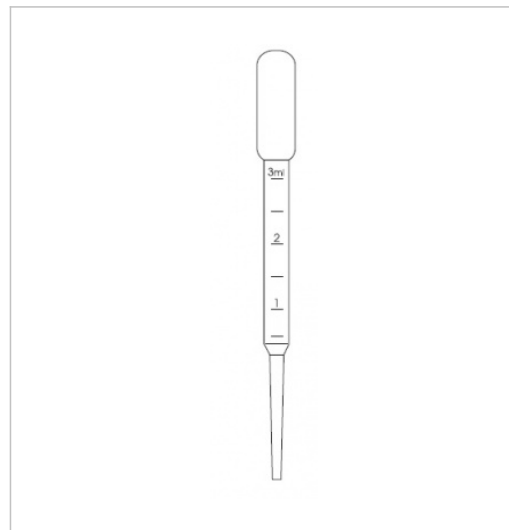

Description:

Flask volume: 4 ml
 Pipette length : 156-159 mm
 Drops per 1 ml: 25 ± 3
 Scale:yes, up to 3 ml

Note:

standard flask

Pipette 204

| | |
|----------------------|--|
| Product No.: | V204406 |
| Name (abbreviation): | Pipette 204 |
| Version: | non sterile |
| Group packaging: | 1 pack./500 pcs 10 pack. x 5.000 pcs/carton |
| Shipping packaging: | 5.000 pcs/carton 75.000 pcs/150 pack./pallet |

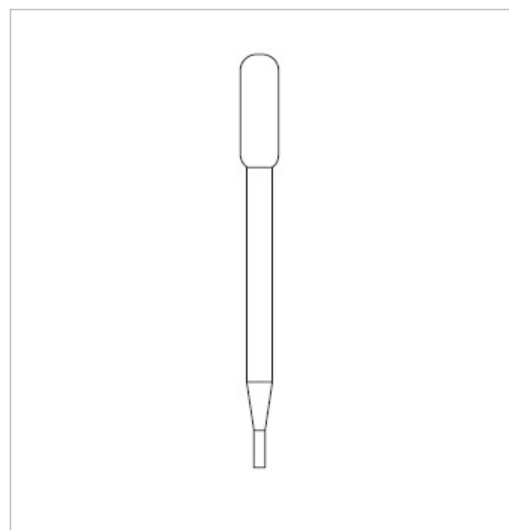

Description:

Flask volume: 4 ml
 Pipette length : 146-148 mm
 Drops per 1 ml: 25 ± 3
 Scale: no

Note:

standard flask

Pipette 206

| | |
|----------------------|--|
| Product No.: | V204506 |
| Name (abbreviation): | Pipette 206 |
| Version: | non sterile |
| Group packaging: | 1 pack./500 pcs 10 pack. x 5.000 pcs/carton |
| Shipping packaging: | 5.000 pcs/carton 75.000 pcs/150 pack./pallet |

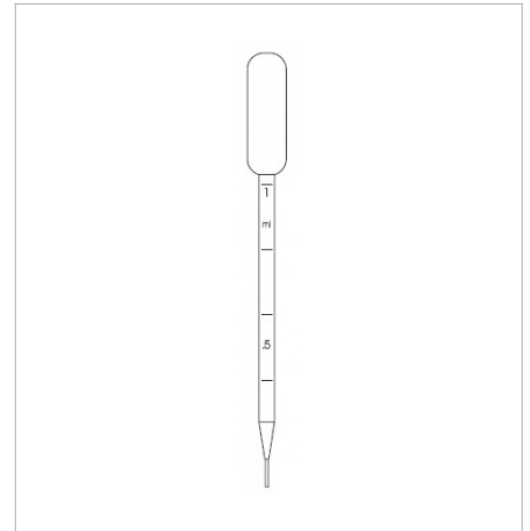

Description:

Flask volume: 4 ml
 Pipette length : 148-151 mm
 Drops per 1 ml: 50 ± 5
 Scale:yes, up to 1 ml

Note:

standard flask, fine tip

Pipette 207

| | |
|----------------------|--|
| Product No.: | V204507 |
| Name (abbreviation): | Pipette 207 |
| Version: | non sterile |
| Group packaging: | 1 pack./500 pcs 10 pack. x 5.000 pcs/carton |
| Shipping packaging: | 5.000 pcs/carton 75.000 pcs/150 pack./pallet |



Description:

Flask volume: 4 ml
 Pipette length : 151-154 mm
 Drops per 1 ml: 30 ± 3
 Scale: no

Note:

standard flask

Pipette 211

| | |
|----------------------|--|
| Product No.: | V204511 |
| Name (abbreviation): | Pipette 211 |
| Version: | non sterile |
| Group packaging: | 1 pack./500 pcs 10 pack. x 5.000 pcs/carton |
| Shipping packaging: | 5.000 pcs/carton 75.000 pcs/150 pack./pallet |

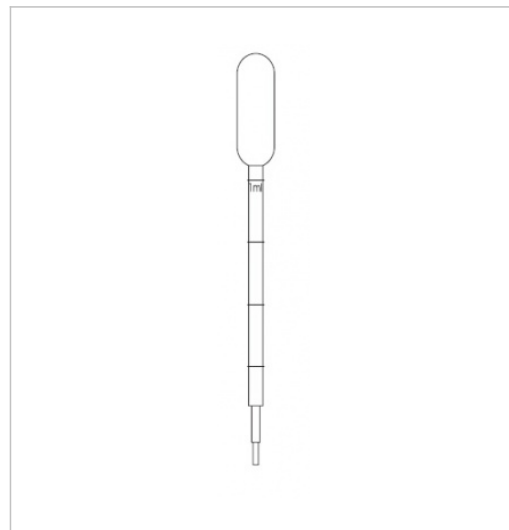

Description:

Flask volume: 4,5 ml
 Pipette length : 151-154 mm
 Drops per 1 ml: 30 ± 3
 Scale:yes, up to 1 ml

Note:

standard flask

Pipette 217

| | |
|----------------------|---|
| Product No.: | V204517 |
| Name (abbreviation): | Pipette 217 |
| Version: | non sterile |
| Group packaging: | 1 pack./500 pcs 10 pack. x 5.000 pcs/carton |
| Shipping packaging: | 5.000 pcs/carton 105.000 pcs/150 pack./pallet |

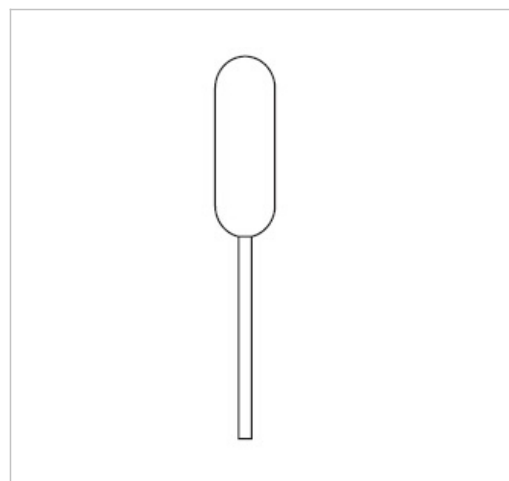

Description:

Flask volume: 4 ml
 Pipette length : 85-87 mm
 Drops per 1 ml: 30 ± 3
 Scale: no

Note:

standard flask

Pipette 220

| | |
|----------------------|--|
| Product No.: | V204504 |
| Name (abbreviation): | Pipette 220 |
| Version: | non sterile |
| Group packaging: | 1 pack./500 pcs 10 pack. x 5.000 pcs/carton |
| Shipping packaging: | 5.000 pcs/carton 75.000 pcs/150 pack./pallet |

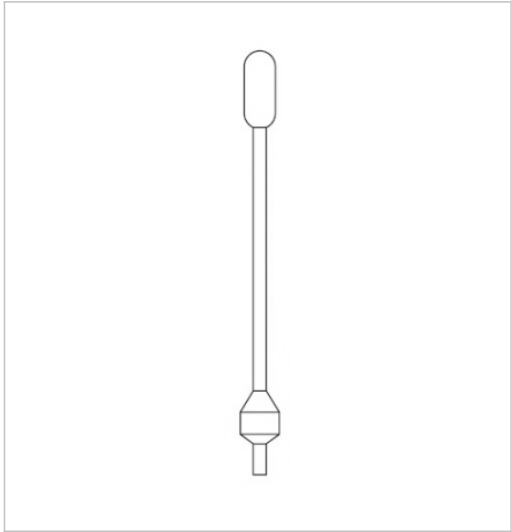

Description:

Flask volume: 1 ml
 Pipette length : 139-142 mm
 Drops per 1 ml: 25 ± 3
 Scale: no

Note:

2 flasks

Pipette 222

| | |
|----------------------|--|
| Product No.: | V204524 |
| Name (abbreviation): | Pipette 222 |
| Version: | non sterile |
| Group packaging: | 1 pack./500 pcs 10 pack. x 5.000 pcs/carton |
| Shipping packaging: | 5.000 pcs/carton 75.000 pcs/150 pack./pallet |

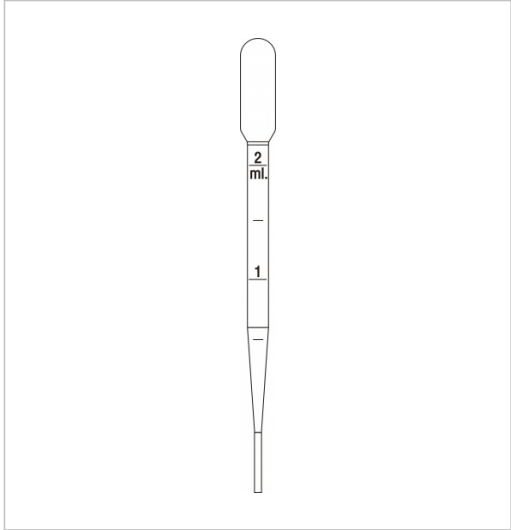

Description:

Flask volume: 3 ml
 Pipette length : 151-153 mm
 Drops per 1 ml: 25 ± 3
 Scale:yes, up to 2 ml

Pipette 223

| | |
|----------------------|--|
| Product No.: | V204523 |
| Name (abbreviation): | Pipette 223 |
| Version: | non sterile |
| Group packaging: | 1 pack./400 pcs 10 pack. x 4.000 pcs/carton |
| Shipping packaging: | 4.000 pcs/carton 60.000 pcs/150 pack./pallet |

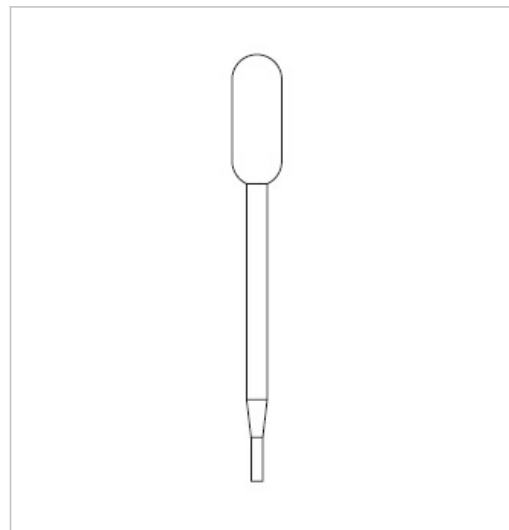

Description:

Flask volume: 6,5 ml
 Pipette length : 147-149 mm
 Drops per 1 ml: 22 ± 2
 Scale: no

Note:

big flask

Pipette 225

| | |
|----------------------|--|
| Product No.: | V204505 |
| Name (abbreviation): | Pipette 225 |
| Version: | non sterile |
| Group packaging: | 1 pack./500 pcs 10 pack. x 5.000 pcs/carton |
| Shipping packaging: | 5.000 pcs/carton 75.000 pcs/150 pack./pallet |

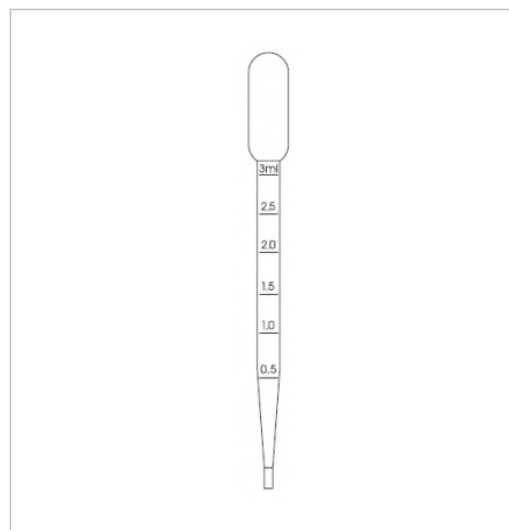

Description:

Flask volume: 4 ml
 Pipette length : 158-161 mm
 Drops per 1 ml: 25 ± 3
 Scale:yes, up to 3 ml

Note:

standard flask

Pipette 406

| | |
|----------------------|--|
| Product No.: | V204508 |
| Name (abbreviation): | Pipette 406 |
| Version: | non sterile |
| Group packaging: | 1 pack./500 pcs 10 pack. x 5.000 pcs/carton |
| Shipping packaging: | 5.000 pcs/carton 75.000 pcs/150 pack./pallet |



Description:

Flask volume: 4 ml
 Pipette length : 147-151 mm
 Drops per 1 ml: 50 ± 5
 Scale: no

Note:

micro tip

Pipette 409

| | |
|----------------------|--|
| Product No.: | V204509 |
| Name (abbreviation): | Pipette 409 |
| Version: | non sterile |
| Group packaging: | 1 pack./500 pcs 10 pack. x 5.000 pcs/carton |
| Shipping packaging: | 5.000 pcs/carton 75.000 pcs/150 pack./pallet |

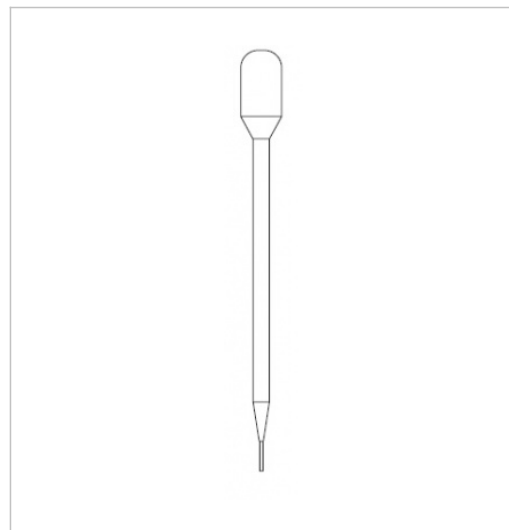

Description:

Flask volume: 2,5 ml
 Pipette length : 132-134 mm
 Drops per 1 ml: 50 ± 5
 Scale: no

Note:

micro tip, small flask

Pipette 423

| | |
|----------------------|---|
| Product No.: | V204522 |
| Name (abbreviation): | Pipette 423 |
| Version: | non sterile |
| Group packaging: | 1 pack./400 pcs 8 pack. x 3.200 pcs/carton |
| Shipping packaging: | 3.200 pcs/carton 192.000 pcs/480 pack./pallet |

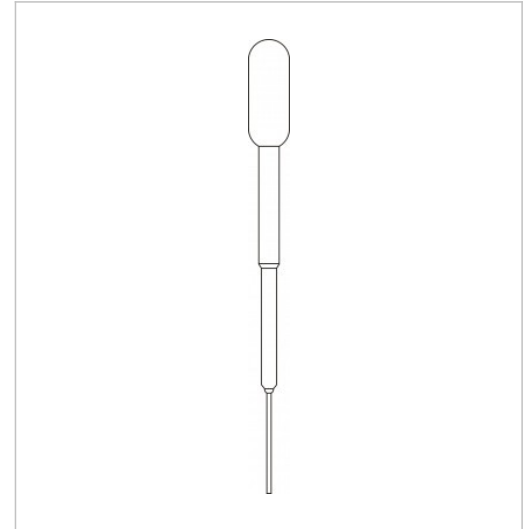

Description:

Flask volume: 1 ml
 Pipette length : 103-105 mm
 Drops per 1 ml: 50 ± 5
 Scale: no

Note:

long micro tip

Pipette 502

| | |
|----------------------|--|
| Product No.: | V204510 |
| Name (abbreviation): | Pipette 502 |
| Version: | non sterile |
| Group packaging: | 1 pack./500 pcs 10 pack. x 5.000 pcs/carton |
| Shipping packaging: | 5.000 pcs/carton 75.000 pcs/150 pack./pallet |

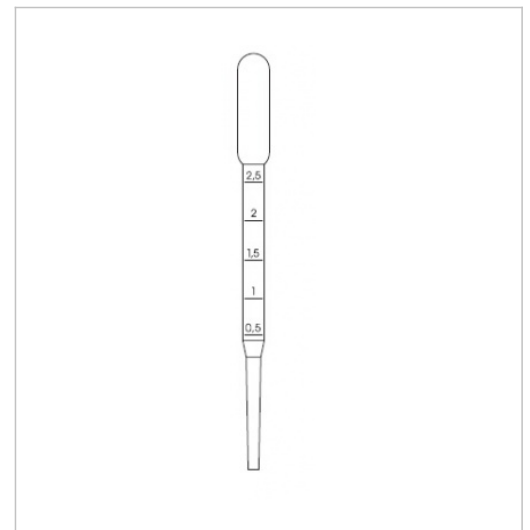

Description:

Flask volume: 4 ml
 Pipette length : 154-157 mm
 Drops per 1 ml: 25 ± 3
 Scale:yes, up to 2,5 ml

Note:

standard flask

Pipette 503

| | |
|----------------------|--|
| Product No.: | V204512 |
| Name (abbreviation): | Pipette 503 |
| Version: | non sterile |
| Group packaging: | 1 pack./500 pcs 10 pack. x 5.000 pcs/carton |
| Shipping packaging: | 5.000 pcs/carton 75.000 pcs/150 pack./pallet |

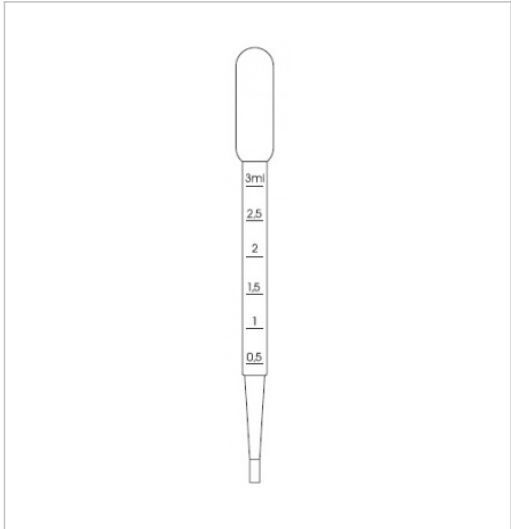

Description:

Flask volume: 4 ml
 Pipette length : 152-155 mm
 Drops per 1 ml: 25 ± 3
 Scale:yes, up to 3 ml

Note:

standard flask

Pipette 509

| | |
|----------------------|--|
| Product No.: | V204513 |
| Name (abbreviation): | Pipette 509 |
| Version: | non sterile |
| Group packaging: | 1 pack./500 pcs 10 pack. x 5.000 pcs/carton |
| Shipping packaging: | 5.000 pcs/carton 75.000 pcs/150 pack./pallet |

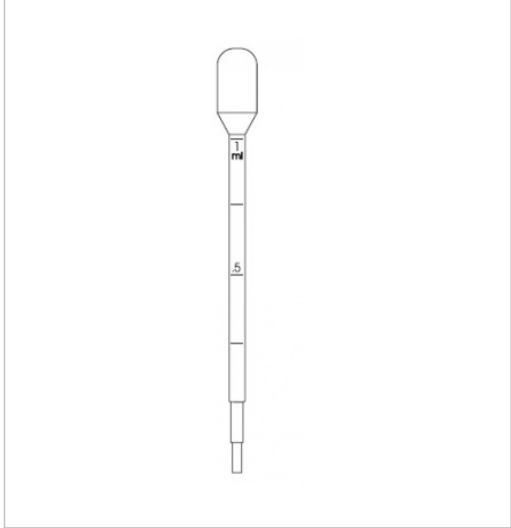

Description:

Flask volume: 2,5 ml
 Pipette length : 138-141 mm
 Drops per 1 ml: 25 ± 3
 Scale:yes, up to 1 ml

Note:

small flask

Pipette 511

| | |
|----------------------|--|
| Product No.: | V204514 |
| Name (abbreviation): | Pipette 511 |
| Version: | non sterile |
| Group packaging: | 1 pack./500 pcs 10 pack. x 5.000 pcs/carton |
| Shipping packaging: | 5.000 pcs/carton 75.000 pcs/150 pack./pallet |



Description:

Flask volume: 4,5 ml
 Pipette length : 151-154 mm
 Drops per 1 ml: 25 ± 3
 Scale:yes, up to 1 ml

Note:

standard flask

Pipette 514

| | |
|----------------------|--|
| Product No.: | V204515 |
| Name (abbreviation): | Pipette 514 |
| Version: | non sterile |
| Group packaging: | 1 pack./500 pcs 10 pack. x 5.000 pcs/carton |
| Shipping packaging: | 5.000 pcs/carton 75.000 pcs/150 pack./pallet |

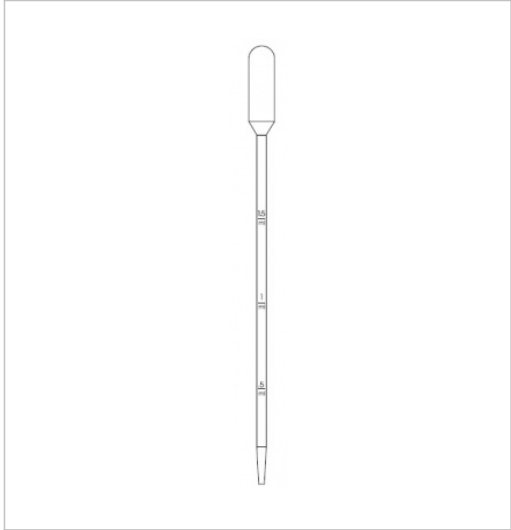

Description:

Flask volume: 4 ml
 Pipette length : 227-230 mm
 Drops per 1 ml: 22 ± 2
 Scale:yes, up to 1,5 ml

Note:

extra long

Pipette 520

| | |
|----------------------|--|
| Product No.: | V204516 |
| Name (abbreviation): | Pipette 520 |
| Version: | non sterile |
| Group packaging: | 1 pack./1.000 pcs 10 pack. x 1.000 pcs/carton |
| Shipping packaging: | 10.000 pcs/carton 210.000 pcs/210 pack./pallet |

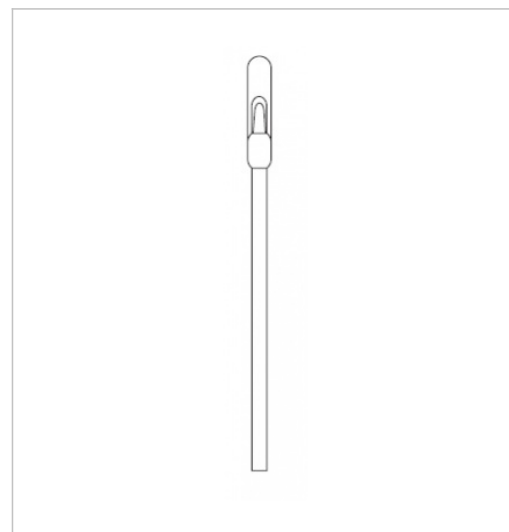

Description:

Flask volume: 0,25 ml
 Pipette length : 122-125 mm
 Drops per 1 ml: 20 ± 2
 Scale: no

Note:

junior

Pipette 521

| | |
|----------------------|--|
| Product No.: | V204518 |
| Name (abbreviation): | Pipette 521 |
| Version: | non sterile |
| Group packaging: | 1 pack./1.000 pcs 10 pack. x 1.000 pcs/carton |
| Shipping packaging: | 10.000 pcs/carton 210.000 pcs/210 pack./pallet |

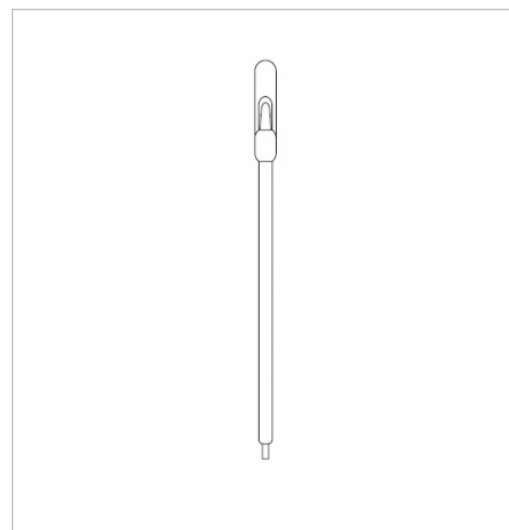

Description:

Flask volume: 0,25 ml
 Pipette length : 129-131 mm
 Drops per 1 ml: 40 ± 4
 Scale: no

Note:

fine tip, junior

Pipette 522

| | |
|----------------------|--|
| Product No.: | V204519 |
| Name (abbreviation): | Pipette 522 |
| Version: | non sterile |
| Group packaging: | 1 pack./1.000 pcs 10 pack. x 1.000 pcs/carton |
| Shipping packaging: | 10.000 pcs/carton 150.000 pcs/150 pack./pallet |

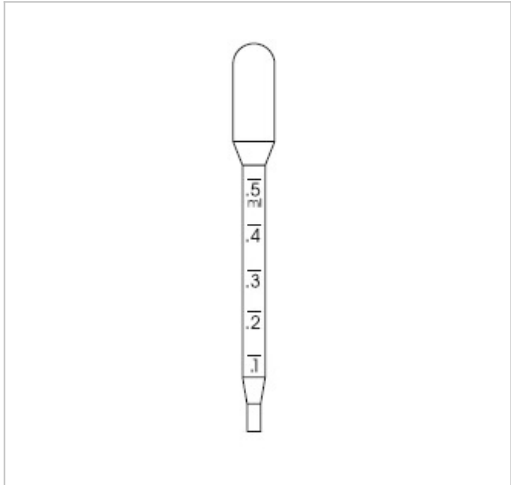

Description:

Flask volume: 1 ml
 Pipette length : 84-87 mm
 Drops per 1 ml: 25 ± 3
 Scale:yes, up to 0,5 ml

Note:

mini

Pipette 523

| | |
|----------------------|--|
| Product No.: | V204520 |
| Name (abbreviation): | Pipette 523 |
| Version: | non sterile |
| Group packaging: | 1 pack./1.000 pcs 10 pack. x 1.000 pcs/carton |
| Shipping packaging: | 10.000 pcs/carton 150.000 pcs/150 pack./pallet |

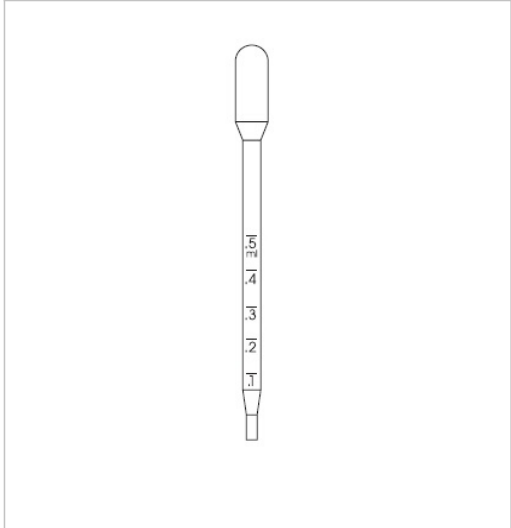

Description:

Flask volume: 1 ml
 Pipette length : 111-114 mm
 Drops per 1 ml: 25 ± 3
 Scale:yes, up to 0,5 ml

Note:

mini plus

Pipette 523-025

| | |
|----------------------|--|
| Product No.: | V204521 |
| Name (abbreviation): | Pipette 523-025 |
| Version: | non sterile |
| Group packaging: | 1 pack./1.000 pcs 10 pack. x 1.000 pcs/carton |
| Shipping packaging: | 10.000 pcs/carton 150.000 pcs/150 pack./pallet |

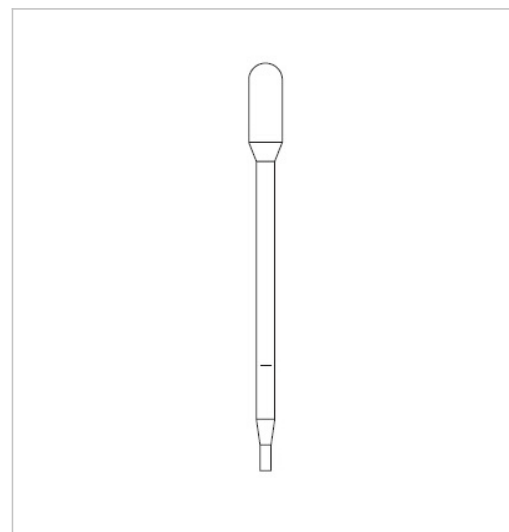

Description:

Flask volume: 1 ml
 Pipette length : 111-114 mm
 Drops per 1 ml: 25 ± 3
 Scale: no

Note:

mini plus

Pipette 540

| | |
|----------------------|--|
| Product No.: | V204525 |
| Name (abbreviation): | Pipette 540 |
| Version: | non sterile |
| Group packaging: | 1 pack./1.000 pcs 100 pack. x 100 pcs/carton |
| Shipping packaging: | 10.000 pcs/carton 250.000 pcs/2500 pack./pallet |

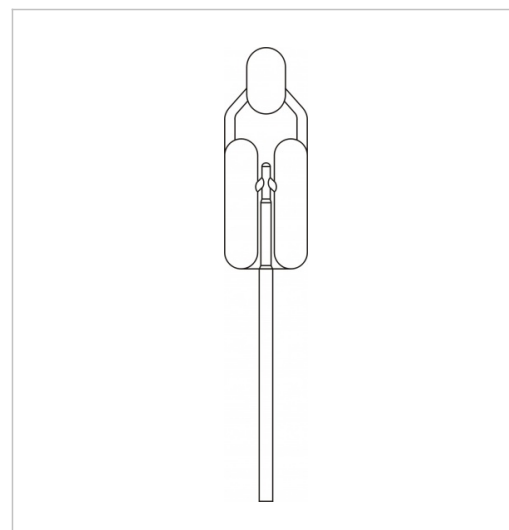

Description:

Pipette length : 81-83 mm
 Scale: no

Note:

Pipette produces 100 µl doses

Pasteur pipettes sterile

The Pasteur pipettes are used particularly in bio-chemical, chemical and micro-biological laboratories for temperatures up to 70°C. They may not be used for oxidizing chemicals. All types of pipettes are produced from clear LDPE, they can be also delivered in different colour depending on customer requirements. Standard version of sterile pipettes - sterilization with ethylenoxide, in packs of 1 pc (S1), 5 pcs (S5), 10 pcs (S10) or 20 pcs (S20).

If requested, the pipettes can be delivered after sterilization in radiation sterilization device.

Pipette 202 S1

| | |
|----------------------|------------------------------------|
| Product No.: | V204012 |
| Name (abbreviation): | Pipette 202 S1 |
| Version: | Sterile-EO |
| Group packaging: | packed in 1 pc |
| Shipping packaging: | 500 pcs/carton 30.000 pcs/pallet |

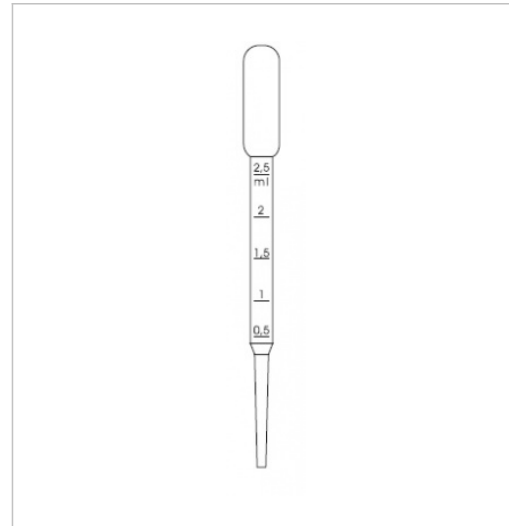

Description:

Flask volume: 4 ml
 Pipette length : 151-154 mm
 Drops per 1 ml: 25 ± 3
 Scale:yes, up to 2,5 ml

Note:

standard flask

Pipette 202 S5

| | |
|----------------------|------------------------------------|
| Product No.: | V204052 |
| Name (abbreviation): | Pipette 202 S5 |
| Version: | Sterile-EO |
| Group packaging: | pack of 5 pcs |
| Shipping packaging: | 500 pcs/carton 30.000 pcs/pallet |

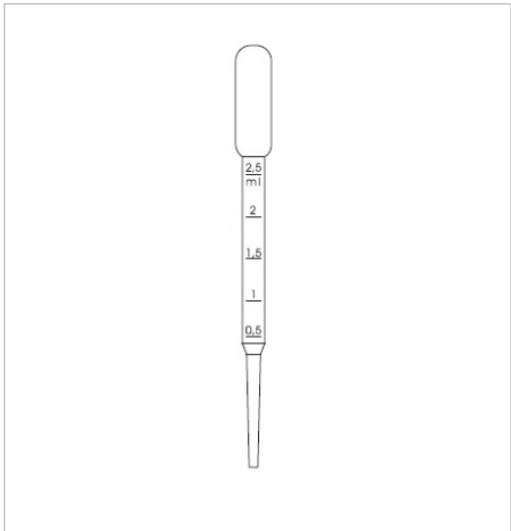

Description:

Flask volume: 4 ml
 Pipette length : 151-154 mm
 Drops per 1 ml: 25 ± 3
 Scale:yes, up to 2,5 ml

Note:

standard flask

Pipette 202 S10

| | |
|----------------------|------------------------------------|
| Product No.: | V204102 |
| Name (abbreviation): | Pipette 202 S10 |
| Version: | Sterile-EO |
| Group packaging: | pack of 10 pcs |
| Shipping packaging: | 500 pcs/carton 30.000 pcs/pallet |

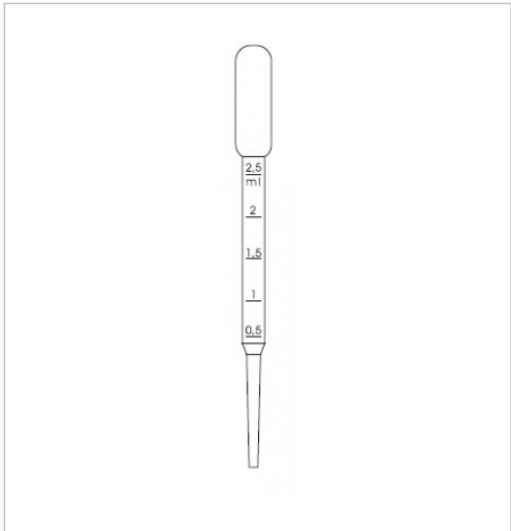

Description:

Flask volume: 4 ml
 Pipette length : 151-154 mm
 Drops per 1 ml: 25 ± 3
 Scale:yes, up to 2,5 ml

Note:

standard flask

Pipette 202 S20

| | |
|----------------------|------------------------------------|
| Product No.: | V204202 |
| Name (abbreviation): | Pipette 202 S20 |
| Version: | Sterile-EO |
| Group packaging: | pack of 20 pcs |
| Shipping packaging: | 500 pcs/carton 30.000 pcs/pallet |

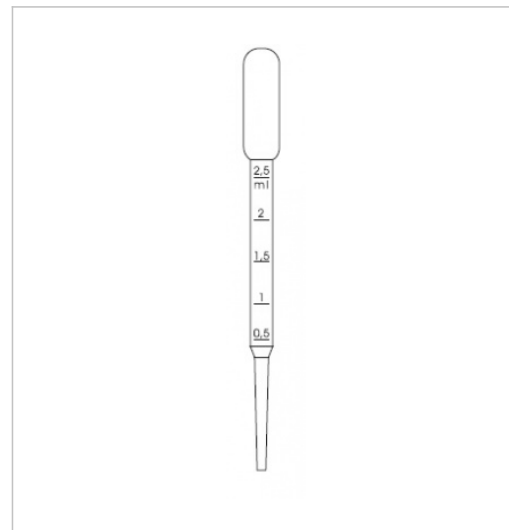

Description:

Flask volume: 4 ml
 Pipette length : 151-154 mm
 Drops per 1 ml: 25 ± 3
 Scale:yes, up to 2,5 ml

Note:

standard flask

Pipette 203 S1

| | |
|----------------------|------------------------------------|
| Product No.: | V204013 |
| Name (abbreviation): | Pipette 203 S1 |
| Version: | Sterile-EO |
| Group packaging: | packed in 1 pc |
| Shipping packaging: | 500 pcs/carton 30.000 pcs/pallet |

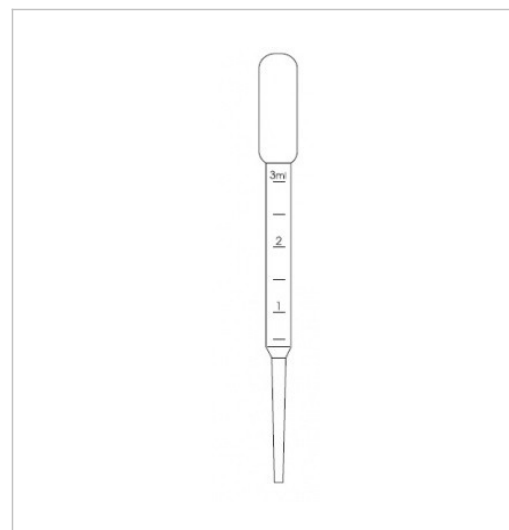

Description:

Flask volume: 4 ml
 Pipette length : 156-159 mm
 Drops per 1 ml: 25 ± 3
 Scale:yes, up to 3 ml

Note:

standard flask

Pipette 203 S5

| | |
|----------------------|------------------------------------|
| Product No.: | V204053 |
| Name (abbreviation): | Pipette 203 S5 |
| Version: | Sterile-EO |
| Group packaging: | pack of 5 pcs |
| Shipping packaging: | 500 pcs/carton 30.000 pcs/pallet |

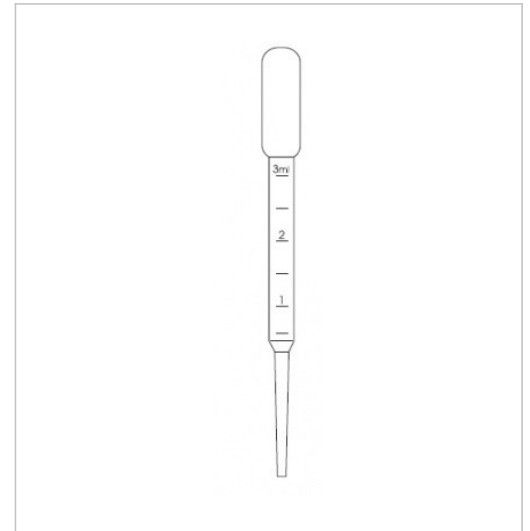

Description:

Flask volume: 4 ml
 Pipette length : 156-159 mm
 Drops per 1 ml: 25 ± 3
 Scale:yes, up to 3 ml

Note:

standard flask

Pipette 203 S10

| | |
|----------------------|------------------------------------|
| Product No.: | V204103 |
| Name (abbreviation): | Pipette 203 S10 |
| Version: | Sterile-EO |
| Group packaging: | pack of 10 pcs |
| Shipping packaging: | 500 pcs/carton 30.000 pcs/pallet |

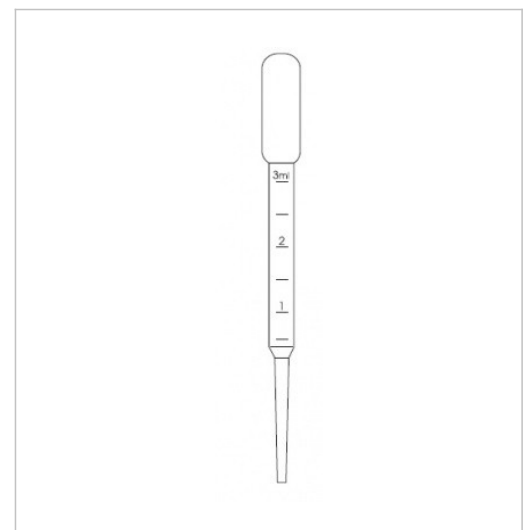

Description:

Flask volume: 4 ml
 Pipette length : 156-159 mm
 Drops per 1 ml: 25 ± 3
 Scale:yes, up to 3 ml

Note:

standard flask

Pipette 203 S20

| | |
|----------------------|------------------------------------|
| Product No.: | V204203 |
| Name (abbreviation): | Pipette 203 S20 |
| Version: | Sterile-EO |
| Group packaging: | pack of 20 pcs |
| Shipping packaging: | 500 pcs/carton 30.000 pcs/pallet |

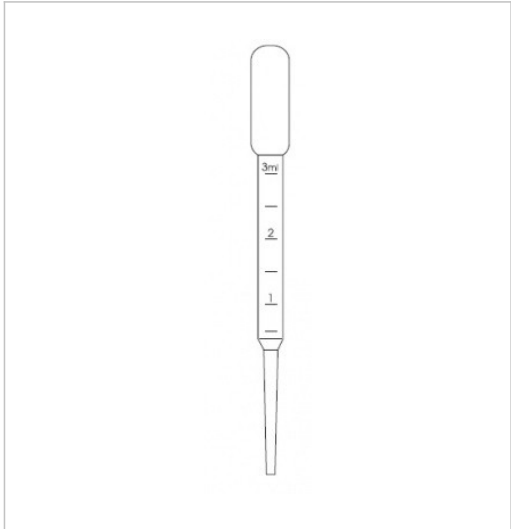

Description:

Flask volume: 4 ml
Pipette length : 156-159 mm
Drops per 1 ml: 25 ± 3
Scale:yes, up to 3 ml

Note:

standard flask

Pipette 204 S1

| | |
|----------------------|------------------------------------|
| Product No.: | V204014 |
| Name (abbreviation): | Pipette 204 S1 |
| Version: | Sterile-EO |
| Group packaging: | packed in 1 pc |
| Shipping packaging: | 500 pcs/carton 30.000 pcs/pallet |

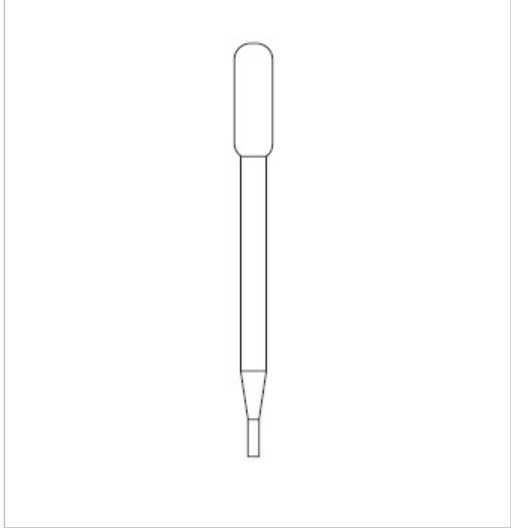

Description:

Flask volume: 4 ml
Pipette length : 146-148 mm
Drops per 1 ml: 25 ± 3
Scale: no

Note:

standard flask

Pipette 204 S5

| | |
|----------------------|------------------------------------|
| Product No.: | V204054 |
| Name (abbreviation): | Pipette 204 S5 |
| Version: | Sterile-EO |
| Group packaging: | pack of 5 pcs |
| Shipping packaging: | 500 pcs/carton 30.000 pcs/pallet |



Description:

Flask volume: 4 ml
Pipette length : 146-148 mm
Drops per 1 ml: 25 kapek \pm 3
Scale: no

Note:

standard flask

Pipette 204 S10

| | |
|----------------------|------------------------------------|
| Product No.: | V204104 |
| Name (abbreviation): | Pipette 204 S10 |
| Version: | Sterile-EO |
| Group packaging: | pack of 10 pcs |
| Shipping packaging: | 500 pcs/carton 30.000 pcs/pallet |

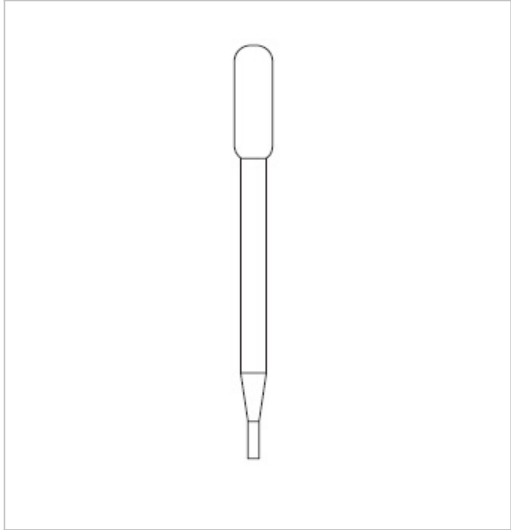

Description:

Flask volume: 4 ml
Pipette length : 146-148 mm
Drops per 1 ml: 25 \pm 3
Scale: no

Note:

standard flask

Pipette 204 S20

| | |
|----------------------|------------------------------------|
| Product No.: | V204204 |
| Name (abbreviation): | Pipette 204 S20 |
| Version: | Sterile-EO |
| Group packaging: | pack of 20 pcs |
| Shipping packaging: | 500 pcs/carton 30.000 pcs/pallet |

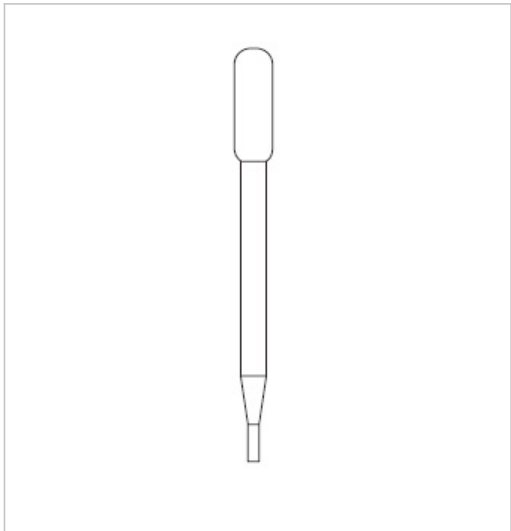

Description:

Flask volume: 4 ml
Pipette length : 146-148 mm
Drops per 1 ml: 25 ± 3
Scale: no

Note:

standard flask

Pipette 206 S1

| | |
|----------------------|------------------------------------|
| Product No.: | V204016 |
| Name (abbreviation): | Pipette 206 S1 |
| Version: | Sterile-EO |
| Group packaging: | packed in 1 pc |
| Shipping packaging: | 500 pcs/carton 30.000 pcs/pallet |

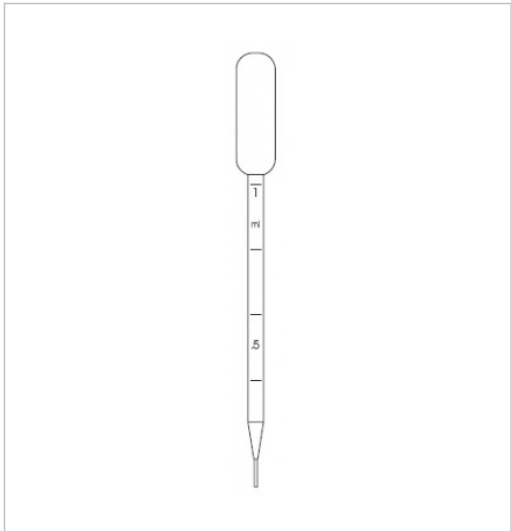

Description:

Flask volume: 4 ml
Pipette length : 148-151 mm
Drops per 1 ml: 50 ± 5
Scale:yes, up to 1 ml

Note:

standard flask, fine tip

Pipette 206 S5

| | |
|----------------------|------------------------------------|
| Product No.: | V204056 |
| Name (abbreviation): | Pipette 206 S5 |
| Version: | Sterile-EO |
| Group packaging: | pack of 5 pcs |
| Shipping packaging: | 500 pcs/carton 30.000 pcs/pallet |

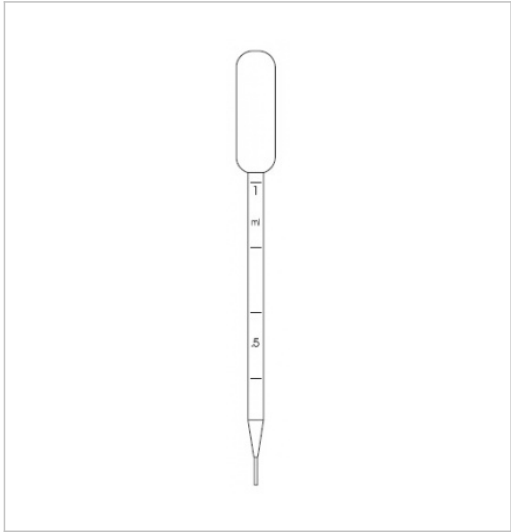

Description:

Flask volume: 4 ml
 Pipette length : 148-151 mm
 Drops per 1 ml: 50 ± 5
 Scale:yes, up to 1 ml

Note:

standard flask, fine tip

Pipette 206 S10

| | |
|----------------------|------------------------------------|
| Product No.: | V204106 |
| Name (abbreviation): | Pipette 206 S10 |
| Version: | Sterile-EO |
| Group packaging: | pack of 10 pcs |
| Shipping packaging: | 500 pcs/carton 30.000 pcs/pallet |

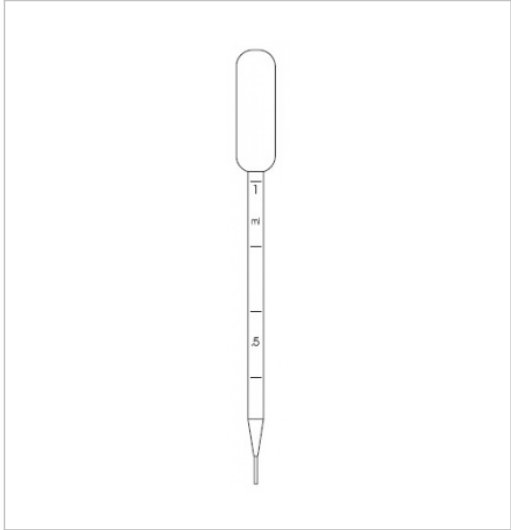

Description:

Flask volume: 4 ml
 Pipette length : 148-151 mm
 Drops per 1 ml: 50 ± 5
 Scale:yes, up to 1 ml

Note:

standard flask, fine tip

Pipette 206 S20

| | |
|----------------------|------------------------------------|
| Product No.: | V204206 |
| Name (abbreviation): | Pipette 206 S20 |
| Version: | Sterile-EO |
| Group packaging: | pack of 20 pcs |
| Shipping packaging: | 500 pcs/carton 30.000 pcs/pallet |

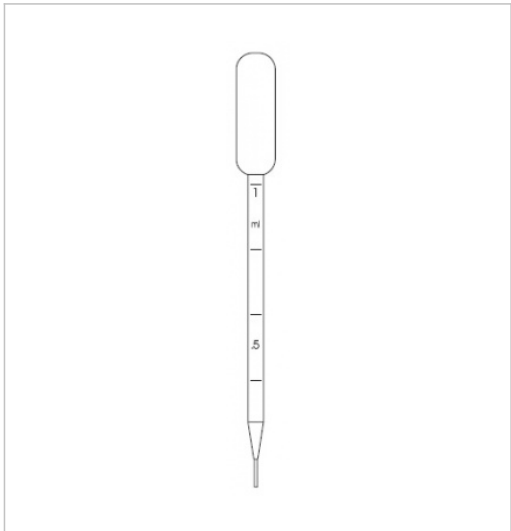

Description:

Flask volume: 4 ml
Pipette length : 148-151 mm
Drops per 1 ml: 50 ± 5
Scale:yes, up to 1 ml

Note:

standard flask, fine tip

Pipette 207 S1

| | |
|----------------------|------------------------------------|
| Product No.: | V204017 |
| Name (abbreviation): | Pipette 207 S1 |
| Version: | Sterile-EO |
| Group packaging: | packed in 1 pc |
| Shipping packaging: | 500 pcs/carton 30.000 pcs/pallet |



Description:

Flask volume: 4 ml
Pipette length : 151-154 mm
Drops per 1 ml: 30 ± 3
Scale: no

Note:

standard flask

Pipette 207 S5

| | |
|----------------------|------------------------------------|
| Product No.: | V204057 |
| Name (abbreviation): | Pipette 207 S5 |
| Version: | Sterile-EO |
| Group packaging: | pack of 5 pcs |
| Shipping packaging: | 500 pcs/carton 30.000 pcs/pallet |



Description:

Flask volume: 4 ml
Pipette length : 151-154 mm
Drops per 1 ml: 30 ± 3
Scale: no

Note:

standard flask

Pipette 207 S10

| | |
|----------------------|------------------------------------|
| Product No.: | V204107 |
| Name (abbreviation): | Pipette 207 S10 |
| Version: | Sterile-EO |
| Group packaging: | pack of 10 pcs |
| Shipping packaging: | 500 pcs/carton 30.000 pcs/pallet |



Description:

Flask volume: 4 ml
Pipette length : 151-154 mm
Drops per 1 ml: 30 ± 3
Scale: no

Note:

standard flask

Pipette 207 S20

| | |
|----------------------|------------------------------------|
| Product No.: | V204207 |
| Name (abbreviation): | Pipette 207 S20 |
| Version: | Sterile-EO |
| Group packaging: | pack of 20 pcs |
| Shipping packaging: | 500 pcs/carton 30.000 pcs/pallet |

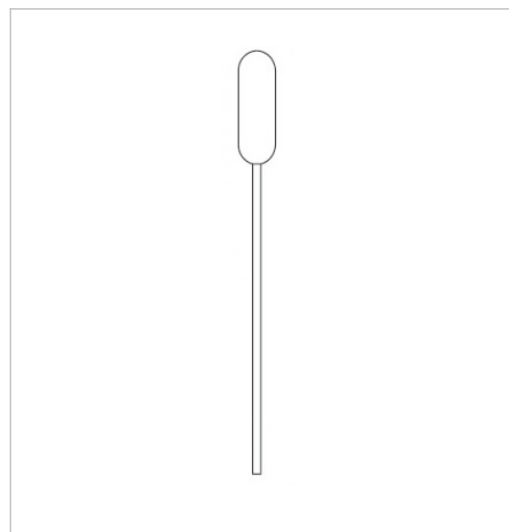

Description:

Flask volume: 4 ml
 Pipette length : 151-154 mm
 Drops per 1 ml: 30 ± 3
 Scale: no

Note:

standard flask

Pipette 211 S1

| | |
|----------------------|----------------------------------|
| Product No.: | V204011 |
| Name (abbreviation): | Pipette 211 S1 |
| Version: | Sterile-EO |
| Group packaging: | packed in 1 pc |
| Shipping packaging: | 500 ks/karton 30 000 ks/paleta |

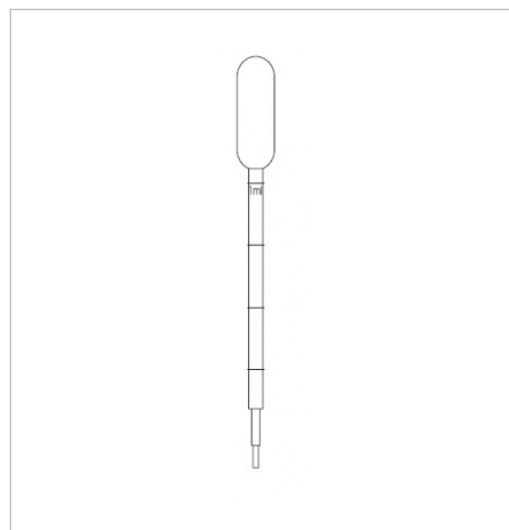

Description:

Flask volume: 4,5 ml
 Pipette length : 151-154 mm
 Drops per 1 ml: 30 ± 3
 Scale:yes, up to 1 ml

Note:

standard flask

Pipette 211 S5

| | |
|----------------------|------------------------------------|
| Product No.: | V204051 |
| Name (abbreviation): | Pipette 211 S5 |
| Version: | Sterile-EO |
| Group packaging: | pack of 5 pcs |
| Shipping packaging: | 500 pcs/carton 30.000 pcs/pallet |

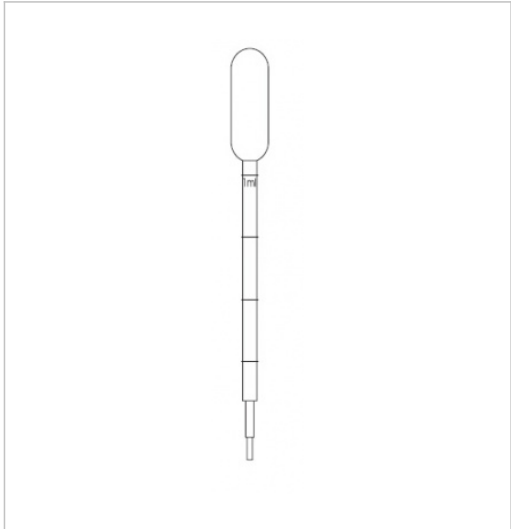

Description:

Flask volume: 4,5 ml
Pipette length : 151-154 mm
Drops per 1 ml: 30 ± 3
Scale:yes, up to 1 ml

Note:

standard flask

Pipette 211 S10

| | |
|----------------------|------------------------------------|
| Product No.: | V204101 |
| Name (abbreviation): | Pipette 211 S10 |
| Version: | Sterile-EO |
| Group packaging: | pack of 10 pcs |
| Shipping packaging: | 500 pcs/carton 30.000 pcs/pallet |

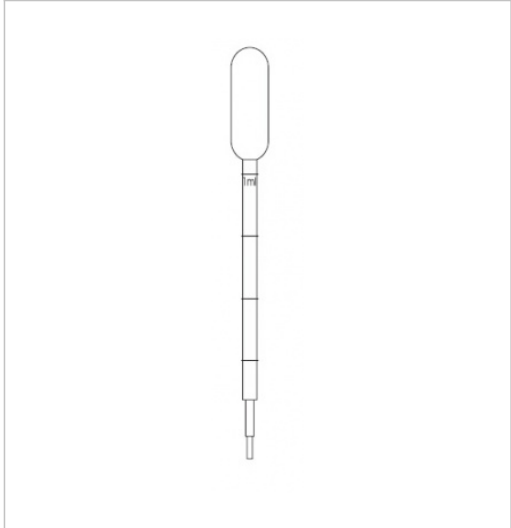

Description:

Flask volume: 4,5 ml
Pipette length : 151-154 mm
Drops per 1 ml: 30 ± 3
Scale:yes, up to 1 ml

Note:

standard flask

Pipette 211 S20

| | |
|----------------------|------------------------------------|
| Product No.: | V204201 |
| Name (abbreviation): | Pipette 211 S20 |
| Version: | Sterile-EO |
| Group packaging: | pack of 20 pcs |
| Shipping packaging: | 500 pcs/carton 30.000 pcs/pallet |

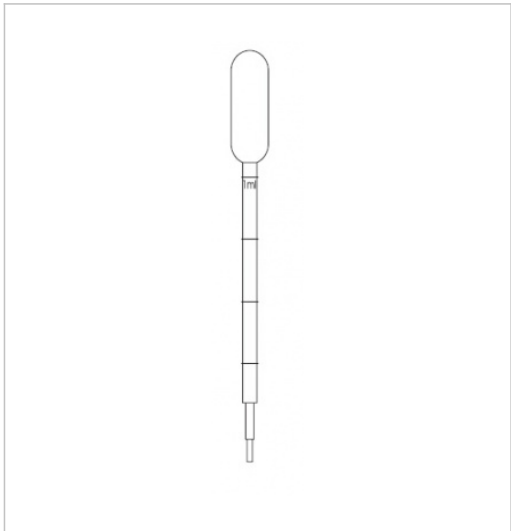

Description:

Flask volume: 4,5 ml
Pipette length : 151-154 mm
Drops per 1 ml: 30 ± 3
Scale:yes, up to 1 ml

Note:

standard flask

Pipette 223 S1

| | |
|----------------------|------------------------------------|
| Product No.: | V204015 |
| Name (abbreviation): | Pipette 223 S1 |
| Version: | Sterile-EO |
| Group packaging: | packed in 1 pc |
| Shipping packaging: | 500 pcs/carton 30.000 pcs/pallet |

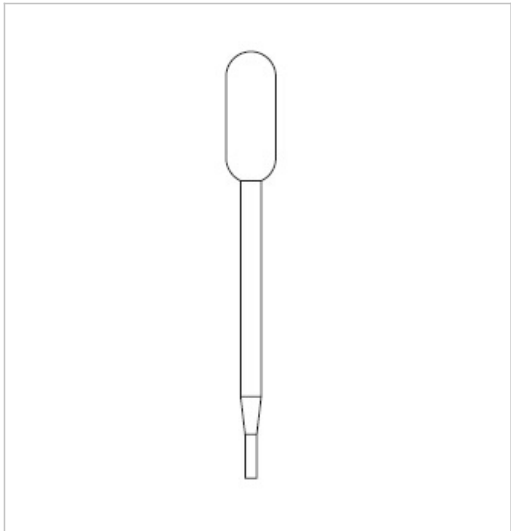

Description:

Flask volume: 6,5 ml
Pipette length : 147-149 mm
Drops per 1 ml: 22 ± 2
Scale: no

Note:

big flask

Pipette 223 S5

| | |
|----------------------|------------------------------------|
| Product No.: | V204055 |
| Name (abbreviation): | Pipette 223 S5 |
| Version: | Sterile-EO |
| Group packaging: | pack of 5 pcs |
| Shipping packaging: | 500 pcs/carton 30.000 pcs/pallet |



Description:

Flask volume: 6,5 ml
Pipette length : 147-149 mm
Drops per 1 ml: 22 ± 2
Scale: no

Note:

big flask

Pipette 223 S10

| | |
|----------------------|------------------------------------|
| Product No.: | V204105 |
| Name (abbreviation): | Pipette 223 S10 |
| Version: | Sterile-EO |
| Group packaging: | pack of 10 pcs |
| Shipping packaging: | 500 pcs/carton 30.000 pcs/pallet |

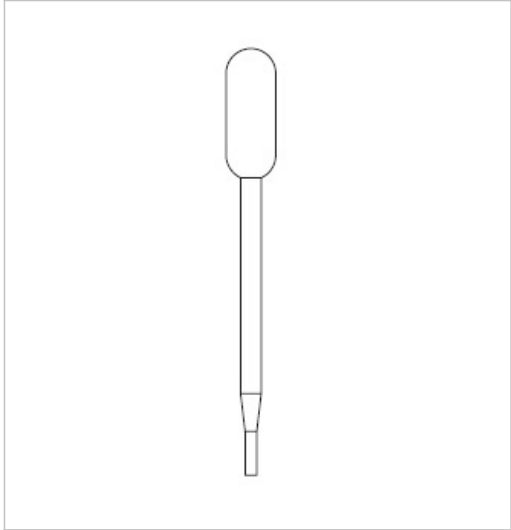

Description:

Flask volume: 6,5 ml
Pipette length : 147-149 mm
Drops per 1 ml: 22 ± 2
Scale: no

Note:

big flask

Pipette 223 S20

| | |
|----------------------|------------------------------------|
| Product No.: | V204205 |
| Name (abbreviation): | Pipette 223 S20 |
| Version: | Sterile-EO |
| Group packaging: | pack of 20 pcs |
| Shipping packaging: | 500 pcs/carton 30.000 pcs/pallet |



Description:

Flask volume: 6,5 ml
Pipette length : 147-149 mm
Drops per 1 ml: 22 ± 2
Scale: no

Note:

big flask

Pipette 225 S1

| | |
|----------------------|------------------------------------|
| Product No.: | V204004 |
| Name (abbreviation): | Pipette 225 S1 |
| Version: | Sterile-EO |
| Group packaging: | packed in 1 pc |
| Shipping packaging: | 500 pcs/carton 30.000 pcs/pallet |

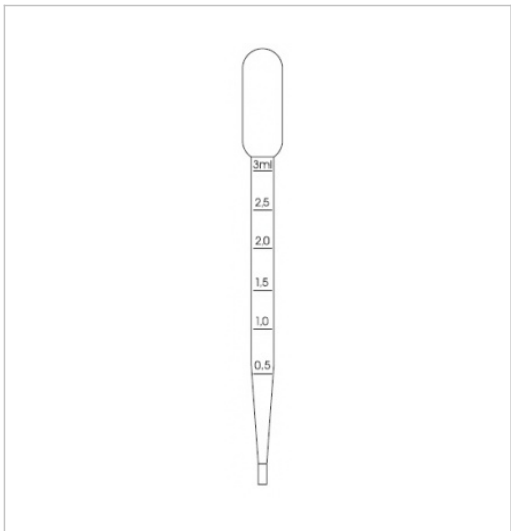

Description:

Flask volume: 4 ml
Pipette length : 158-161 mm
Drops per 1 ml: 25 ± 3
Scale:yes, up to 3 ml

Note:

standard flask

Pipette 225 S5

| | |
|----------------------|------------------------------------|
| Product No.: | V204047 |
| Name (abbreviation): | Pipette 225 S5 |
| Version: | Sterile-EO |
| Group packaging: | pack of 5 pcs |
| Shipping packaging: | 500 pcs/carton 30.000 pcs/pallet |



Description:

Flask volume: 4 ml
Pipette length : 158-161 mm
Drops per 1 ml: 25 ± 3
Scale:yes, up to 3 ml

Note:

standard flask

Pipette 225 S10

| | |
|----------------------|------------------------------------|
| Product No.: | V204088 |
| Name (abbreviation): | Pipette 225 S10 |
| Version: | Sterile-EO |
| Group packaging: | pack of 10 pcs |
| Shipping packaging: | 500 pcs/carton 30.000 pcs/pallet |

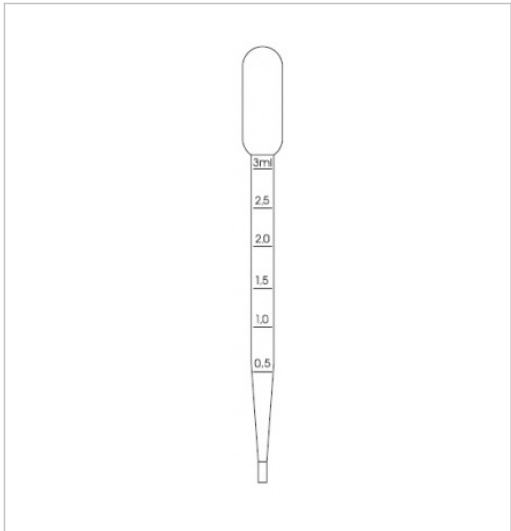

Description:

Flask volume: 4 ml
Pipette length : 158-161 mm
Drops per 1 ml: 25 ± 3
Scale:yes, up to 3 ml

Note:

standard flask

Pipette 225 S20

| | |
|----------------------|------------------------------------|
| Product No.: | V204188 |
| Name (abbreviation): | Pipette 225 S20 |
| Version: | Sterile-EO |
| Group packaging: | pack of 20 pcs |
| Shipping packaging: | 500 pcs/carton 30.000 pcs/pallet |



Description:

Flask volume: 4 ml
 Pipette length : 158-161 mm
 Drops per 1 ml: 25 ± 3
 Scale:yes, up to 3 ml

Note:

standard flask

Pipette 406 S1

| | |
|----------------------|------------------------------------|
| Product No.: | V204005 |
| Name (abbreviation): | Pipette 406 S1 |
| Version: | Sterile-EO |
| Group packaging: | packed in 1 pc |
| Shipping packaging: | 500 pcs/carton 30.000 pcs/pallet |

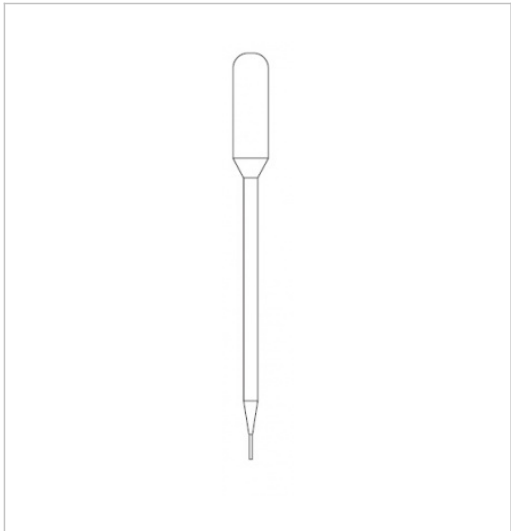

Description:

Flask volume: 4 ml
 Pipette length : 147-151 mm
 Drops per 1 ml: 50 ± 5
 Scale: no

Note:

micro tip

Pipette 406 S5

| | |
|----------------------|------------------------------------|
| Product No.: | V204048 |
| Name (abbreviation): | Pipette 406 S5 |
| Version: | Sterile-EO |
| Group packaging: | pack of 5 pcs |
| Shipping packaging: | 500 pcs/carton 30.000 pcs/pallet |

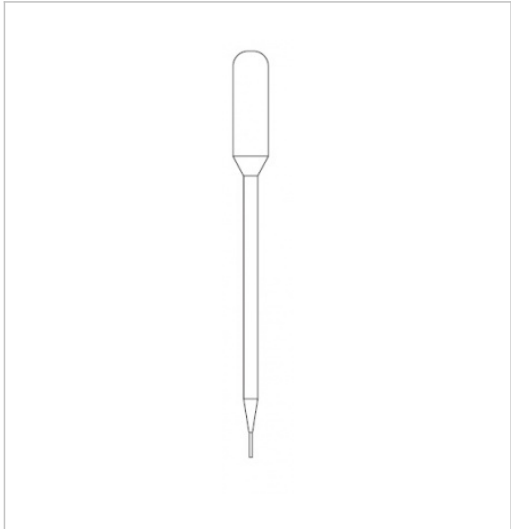

Description:

Flask volume: 4 ml
Pipette length : 147-151 mm
Drops per 1 ml: 50 ± 5
Scale: no

Note:

micro tip

Pipette 406 S10

| | |
|----------------------|------------------------------------|
| Product No.: | V204089 |
| Name (abbreviation): | Pipette 406 S10 |
| Version: | Sterile-EO |
| Group packaging: | pack of 10 pcs |
| Shipping packaging: | 500 pcs/carton 30.000 pcs/pallet |

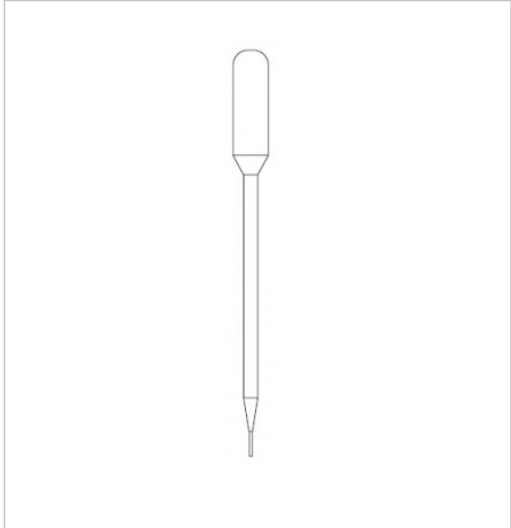

Description:

Flask volume: 4 ml
Pipette length : 147-151 mm
Drops per 1 ml: 50 ± 5
Scale: no

Note:

micro tip

Pipette 406 S20

| | |
|----------------------|------------------------------------|
| Product No.: | V204189 |
| Name (abbreviation): | Pipette 406 S20 |
| Version: | Sterile-EO |
| Group packaging: | pack of 20 pcs |
| Shipping packaging: | 500 pcs/carton 30.000 pcs/pallet |

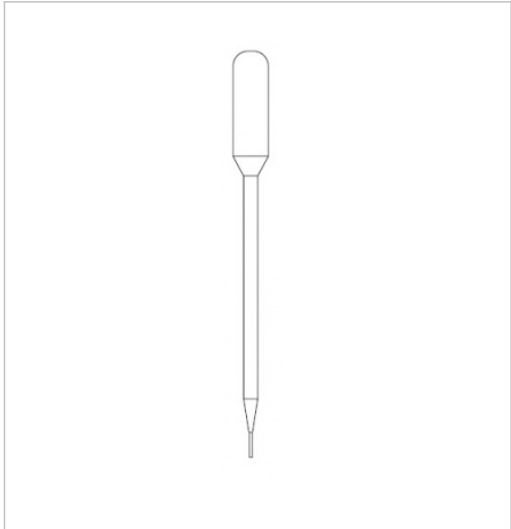

Description:

Flask volume: 4 ml
Pipette length : 147-151 mm
Drops per 1 ml: 50 ± 5
Scale: no

Note:

micro tip

Pipette 409 S1

| | |
|----------------------|------------------------------------|
| Product No.: | V204006 |
| Name (abbreviation): | Pipette 409 S1 |
| Version: | Sterile-EO |
| Group packaging: | packed in 1 pc |
| Shipping packaging: | 500 pcs/carton 30.000 pcs/pallet |

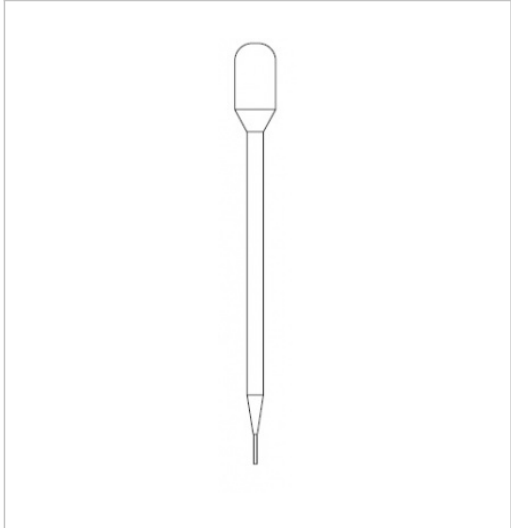

Description:

Flask volume: 2,5 ml
Pipette length : 132-134 mm
Drops per 1 ml: 50 ± 5
Scale: no

Note:

micro tip, small flask

Pipette 409 S5

| | |
|----------------------|------------------------------------|
| Product No.: | V204049 |
| Name (abbreviation): | Pipette 409 S5 |
| Version: | Sterile-EO |
| Group packaging: | pack of 5 pcs |
| Shipping packaging: | 500 pcs/carton 30.000 pcs/pallet |

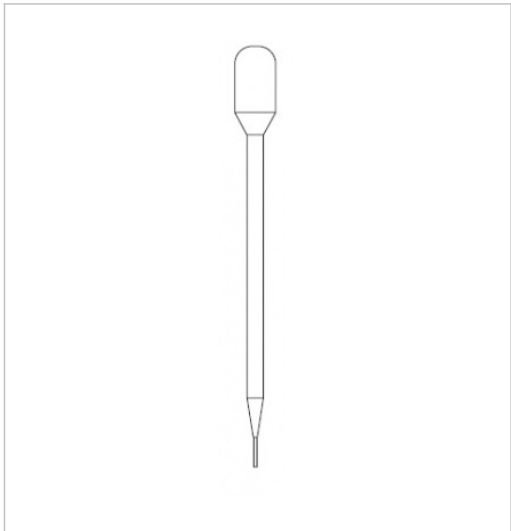

Description:

Flask volume: 2,5 ml
Pipette length : 132-134 mm
Drops per 1 ml: 50 ± 5
Scale: no

Note:

micro tip, small flask

Pipette 409 S10

| | |
|----------------------|------------------------------------|
| Product No.: | V204090 |
| Name (abbreviation): | Pipette 409 S10 |
| Version: | Sterile-EO |
| Group packaging: | pack of 10 pcs |
| Shipping packaging: | 500 pcs/carton 30.000 pcs/pallet |

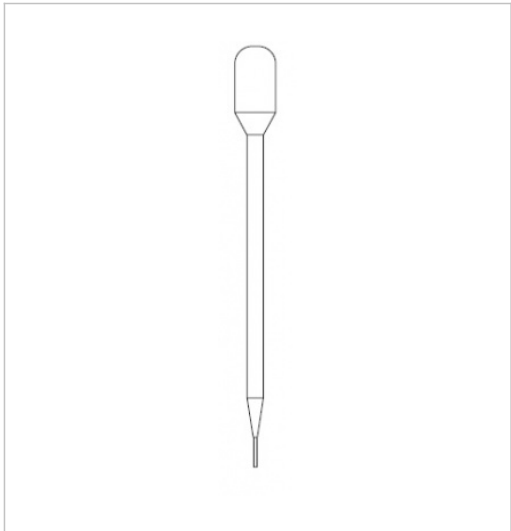

Description:

Flask volume: 2,5 ml
Pipette length : 132-134 mm
Drops per 1 ml: 50 ± 5
Scale: no

Note:

micro tip, small flask

Pipette 409 S20

| | |
|----------------------|------------------------------------|
| Product No.: | V204190 |
| Name (abbreviation): | Pipette 409 S20 |
| Version: | Sterile-EO |
| Group packaging: | pack of 20 pcs |
| Shipping packaging: | 500 pcs/carton 30.000 pcs/pallet |

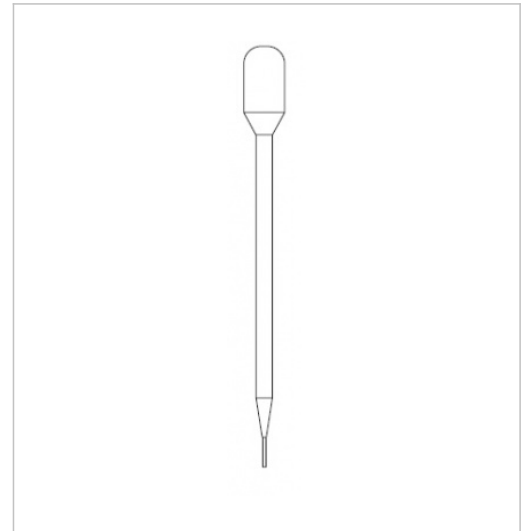

Description:

Flask volume: 2,5 ml
Pipette length : 132-134 mm
Drops per 1 ml: 50 ± 5
Scale: no

Note:

micro tip, small flask

Pipette 423 S1

| | |
|----------------------|------------------------------------|
| Product No.: | V204018 |
| Name (abbreviation): | Pipette 423 S1 |
| Version: | Sterile-EO |
| Group packaging: | packed in 1 pc |
| Shipping packaging: | 500 pcs/carton 30.000 pcs/pallet |

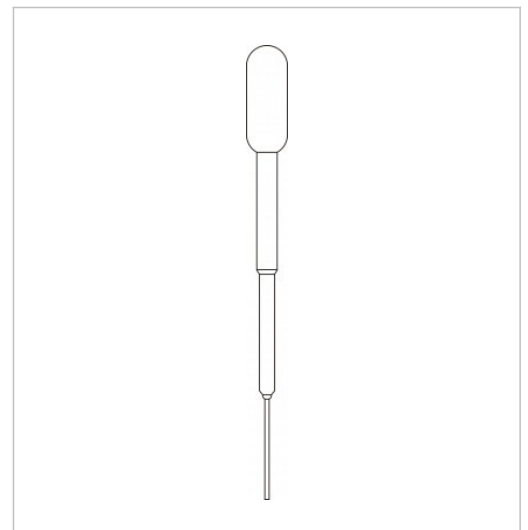

Description:

Flask volume: 1 ml
Pipette length : 103-105 mm
Drops per 1 ml: 50 ± 5
Scale: no

Note:

long micro tip

Pipette 502 S1

| | |
|----------------------|------------------------------------|
| Product No.: | V204007 |
| Name (abbreviation): | Pipette 502 S1 |
| Version: | Sterile-EO |
| Group packaging: | packed in 1 pc |
| Shipping packaging: | 500 pcs/carton 30.000 pcs/pallet |

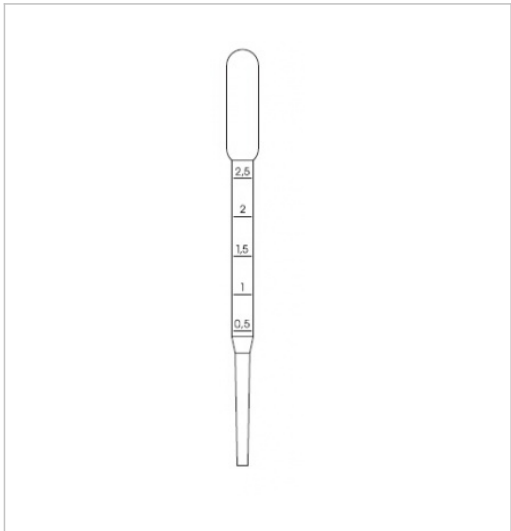

Description:

Flask volume: 4 ml
Pipette length : 154-157 mm
Drops per 1 ml: 25 ± 3
Scale:yes, up to 2,5 ml

Note:

standard flask

Pipette 502 S5

| | |
|----------------------|------------------------------------|
| Product No.: | V204050 |
| Name (abbreviation): | Pipette 502 S5 |
| Version: | Sterile-EO |
| Group packaging: | pack of 5 pcs |
| Shipping packaging: | 500 pcs/carton 30.000 pcs/pallet |

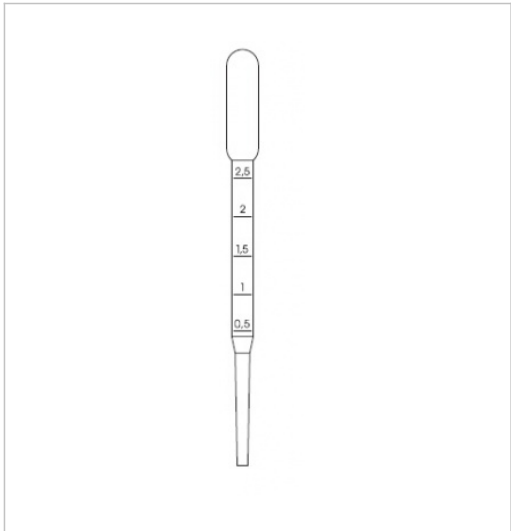

Description:

Flask volume: 4 ml
Pipette length : 154-157 mm
Drops per 1 ml: 25 ± 3
Scale:yes, up to 2,5 ml

Note:

standard flask

Pipette 502 S10

| | |
|----------------------|------------------------------------|
| Product No.: | V204091 |
| Name (abbreviation): | Pipette 502 S10 |
| Version: | Sterile-EO |
| Group packaging: | pack of 10 pcs |
| Shipping packaging: | 500 pcs/carton 30.000 pcs/pallet |

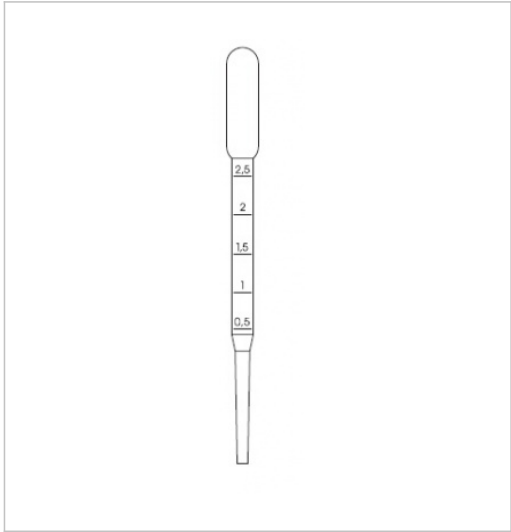

Description:

Flask volume: 4 ml
Pipette length : 154-157 mm
Drops per 1 ml: 25 ± 3
Scale:yes, up to 2,5 ml

Note:

standard flask

Pipette 502 S20

| | |
|----------------------|------------------------------------|
| Product No.: | V204191 |
| Name (abbreviation): | Pipette 502 S20 |
| Version: | Sterile-EO |
| Group packaging: | pack of 20 pcs |
| Shipping packaging: | 500 pcs/carton 30.000 pcs/pallet |

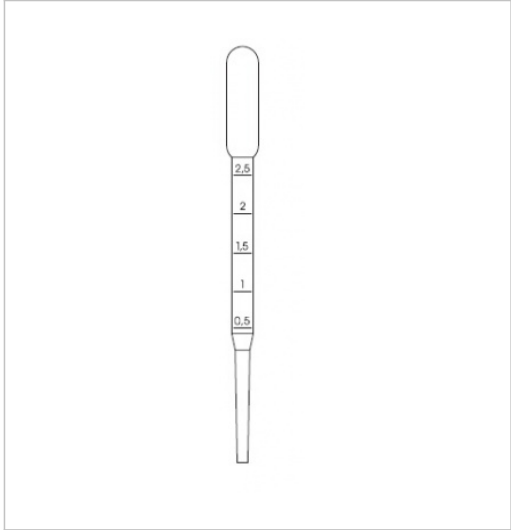

Description:

Flask volume: 4 ml
Pipette length : 154-157 mm
Drops per 1 ml: 25 ± 3
Scale:yes, up to 2,5 ml

Note:

standard flask

Pipette 503 S1

| | |
|----------------------|------------------------------------|
| Product No.: | V204008 |
| Name (abbreviation): | Pipette 503 S1 |
| Version: | Sterile-EO |
| Group packaging: | packed in 1 pc |
| Shipping packaging: | 500 pcs/carton 30.000 pcs/pallet |

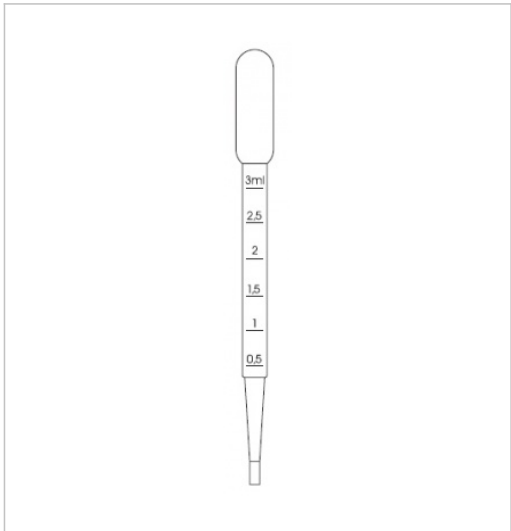

Description:

Flask volume: 4 ml
 Pipette length : 152-155 mm
 Drops per 1 ml: 25 ± 3
 Scale:yes, up to 3 ml

Note:

standard flask

Pipette 503 S5

| | |
|----------------------|------------------------------------|
| Product No.: | V204058 |
| Name (abbreviation): | Pipette 503 S5 |
| Version: | Sterile-EO |
| Group packaging: | pack of 5 pcs |
| Shipping packaging: | 500 pcs/carton 30.000 pcs/pallet |

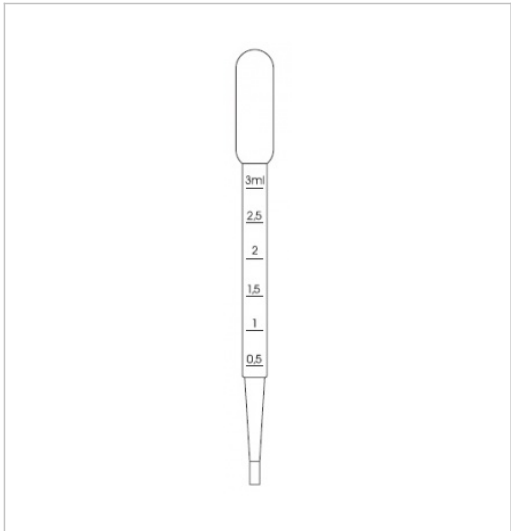

Description:

Flask volume: 4 ml
 Pipette length : 152-155 mm
 Drops per 1 ml: 25 ± 3
 Scale:yes, up to 3 ml

Note:

standard flask

Pipette 503 S10

| | |
|----------------------|------------------------------------|
| Product No.: | V204092 |
| Name (abbreviation): | Pipette 503 S10 |
| Version: | Sterile-EO |
| Group packaging: | pack of 10 pcs |
| Shipping packaging: | 500 pcs/carton 30.000 pcs/pallet |

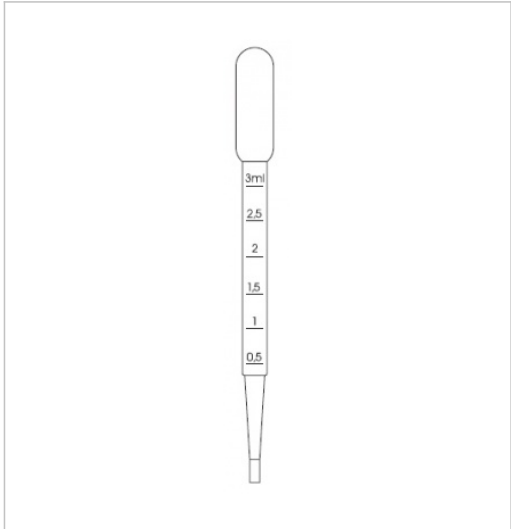

Description:

Flask volume: 4 ml
 Pipette length : 152-155 mm
 Drops per 1 ml: 25 ± 3
 Scale:yes, up to 3 ml

Note:

standard flask

Pipette 503 S20

| | |
|----------------------|------------------------------------|
| Product No.: | V204192 |
| Name (abbreviation): | Pipette 503 S20 |
| Version: | Sterile-EO |
| Group packaging: | pack of 20 pcs |
| Shipping packaging: | 500 pcs/carton 30.000 pcs/pallet |

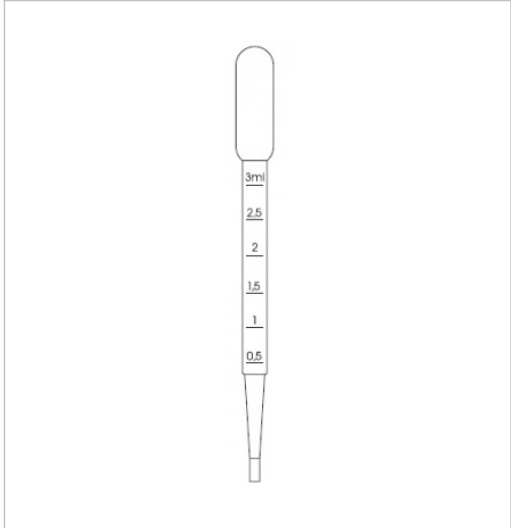

Description:

Flask volume: 4 ml
 Pipette length : 152-155 mm
 Drops per 1 ml: 25 ± 3
 Scale:yes, up to 3 ml

Note:

standard flask

Pipette 509 S1

| | |
|----------------------|------------------------------------|
| Product No.: | V204009 |
| Name (abbreviation): | Pipette 509 S1 |
| Version: | Sterile-EO |
| Group packaging: | packed in 1 pc |
| Shipping packaging: | 500 pcs/carton 30.000 pcs/pallet |

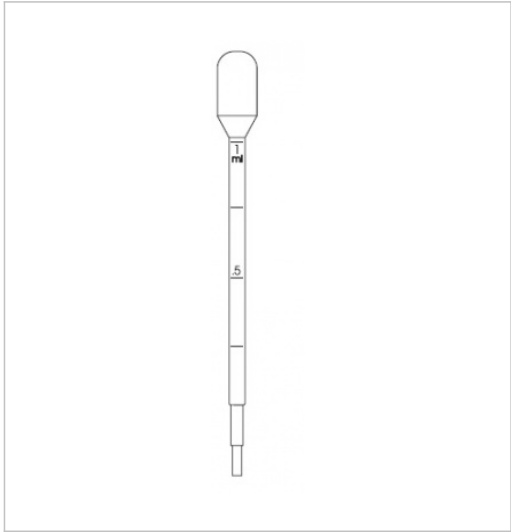

Description:

Flask volume: 2,5 ml
Pipette length : 138-141 mm
Drops per 1 ml: 25 ± 3
Scale:yes, up to 1 ml

Note:

small flask

Pipette 509 S5

| | |
|----------------------|------------------------------------|
| Product No.: | V204059 |
| Name (abbreviation): | Pipette 509 S5 |
| Version: | Sterile-EO |
| Group packaging: | pack of 5 pcs |
| Shipping packaging: | 500 pcs/carton 30.000 pcs/pallet |

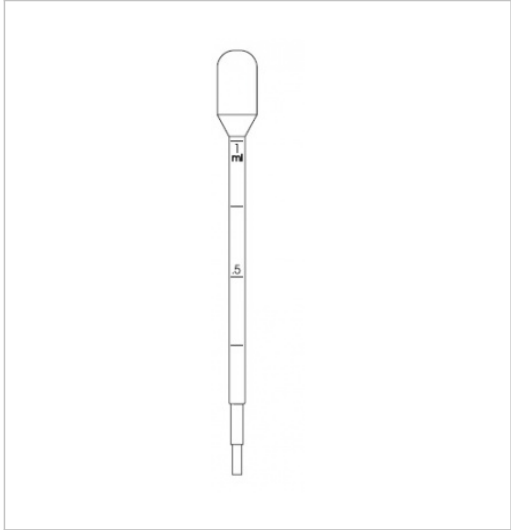

Description:

Flask volume: 2,5 ml
Pipette length : 138-141 mm
Drops per 1 ml: 25 ± 3
Scale:yes, up to 1 ml

Note:

small flask

Pipette 509 S10

| | |
|----------------------|------------------------------------|
| Product No.: | V204093 |
| Name (abbreviation): | Pipette 509 S10 |
| Version: | Sterile-EO |
| Group packaging: | pack of 10 pcs |
| Shipping packaging: | 500 pcs/carton 30.000 pcs/pallet |



Description:

Flask volume: 2,5 ml
Pipette length : 138-141 mm
Drops per 1 ml: 25 ± 3
Scale:yes, up to 1 ml

Note:

small flask

Pipette 509 S20

| | |
|----------------------|------------------------------------|
| Product No.: | V204193 |
| Name (abbreviation): | Pipette 509 S20 |
| Version: | Sterile-EO |
| Group packaging: | pack of 20 pcs |
| Shipping packaging: | 500 pcs/carton 30.000 pcs/pallet |

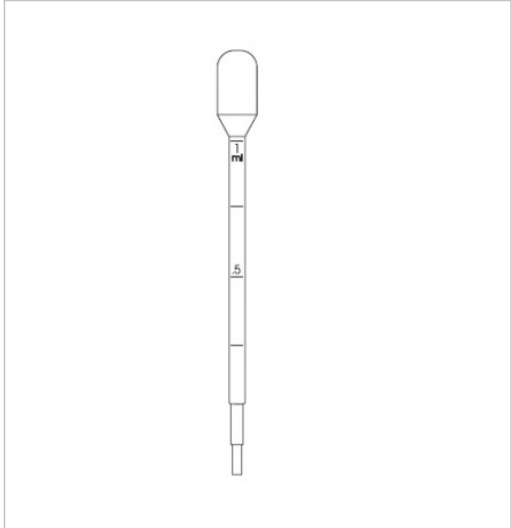

Description:

Flask volume: 2,5 ml
Pipette length : 138-141 mm
Drops per 1 ml: 25 ± 3
Scale:yes, up to 1 ml

Note:

small flask

Pipette 511 S1

| | |
|----------------------|------------------------------------|
| Product No.: | V204010 |
| Name (abbreviation): | Pipette 511 S1 |
| Version: | Sterile-EO |
| Group packaging: | packed in 1 pc |
| Shipping packaging: | 500 pcs/carton 30.000 pcs/pallet |

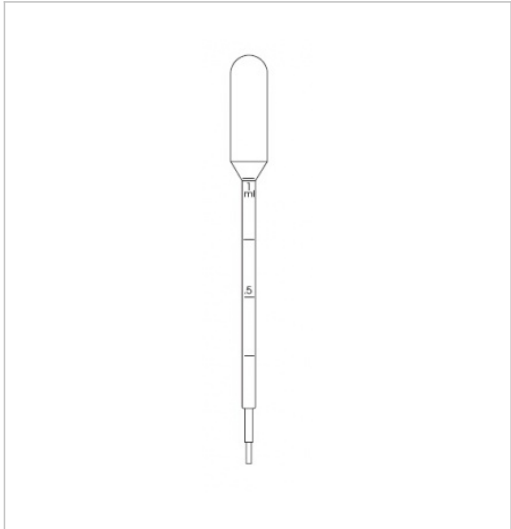

Description:

Flask volume: 4,5 ml
Pipette length : 151-154 mm
Drops per 1 ml: 25 ± 3
Scale:yes, up to 1 ml

Note:

standard flask

Pipette 511 S5

| | |
|----------------------|------------------------------------|
| Product No.: | V204060 |
| Name (abbreviation): | Pipette 511 S5 |
| Version: | Sterile-EO |
| Group packaging: | pack of 5 pcs |
| Shipping packaging: | 500 pcs/carton 30.000 pcs/pallet |

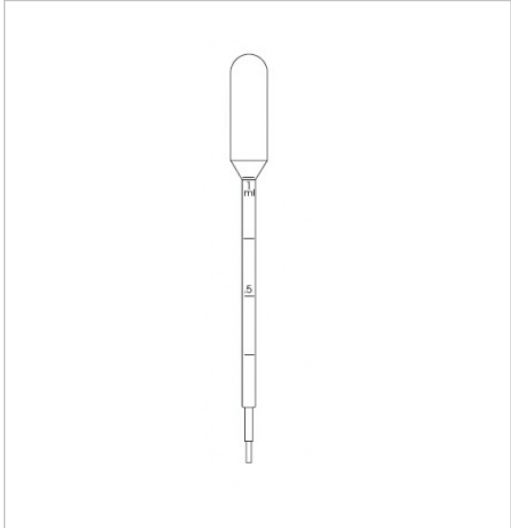

Description:

Flask volume: 4,5 ml
Pipette length : 151-154 mm
Drops per 1 ml: 25 ± 3
Scale:yes, up to 1 ml

Note:

standard flask

Pipette 511 S10

| | |
|----------------------|------------------------------------|
| Product No.: | V204094 |
| Name (abbreviation): | Pipette 511 S10 |
| Version: | Sterile-EO |
| Group packaging: | pack of 10 pcs |
| Shipping packaging: | 500 pcs/carton 30.000 pcs/pallet |

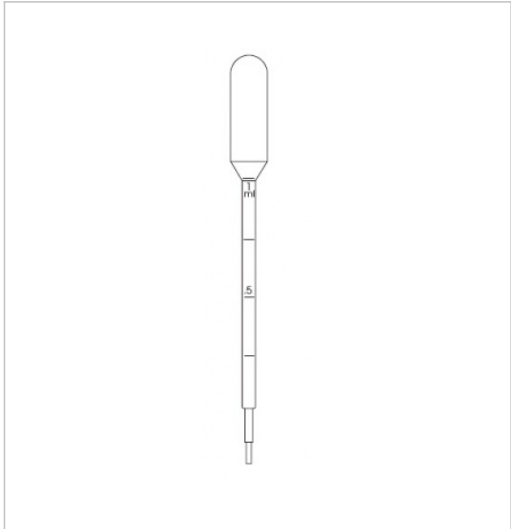

Description:

Flask volume: 4,5 ml
Pipette length : 151-154 mm
Drops per 1 ml: 25 ± 3
Scale:yes, up to 1 ml

Note:

standard flask

Pipette 511 S20

| | |
|----------------------|------------------------------------|
| Product No.: | V204194 |
| Name (abbreviation): | Pipette 511 S20 |
| Version: | Sterile-EO |
| Group packaging: | pack of 20 pcs |
| Shipping packaging: | 500 pcs/carton 30.000 pcs/pallet |

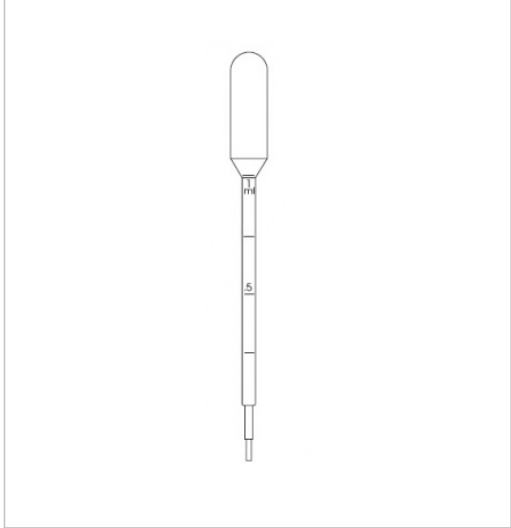

Description:

Flask volume: 4,5 ml
Pipette length : 151-154 mm
Drops per 1 ml: 25 ± 3
Scale:yes, up to 1 ml

Note:

standard flask

Pipette 514 S5

| | |
|----------------------|------------------------------------|
| Product No.: | V204061 |
| Name (abbreviation): | Pipette 514 S5 |
| Version: | Sterile-EO |
| Group packaging: | pack of 5 pcs |
| Shipping packaging: | 500 pcs/carton 12.000 pcs/pallet |

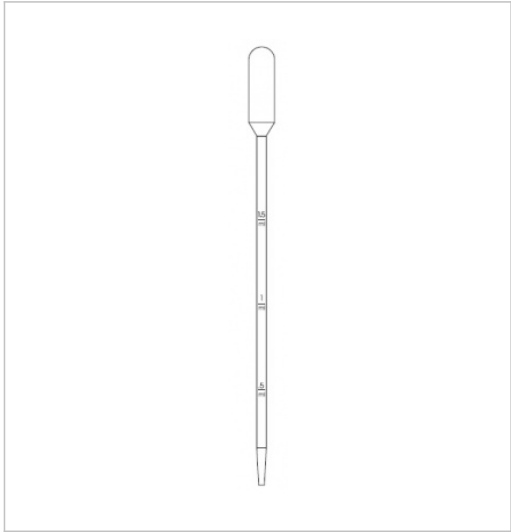

Description:

Flask volume: 4 ml
Pipette length : 227-230 mm
Drops per 1 ml: 22 ± 2
Scale:yes, up to 1,5 ml

Note:

extra long

VET veterinary technical devices

HEMOS taking sets

HEMOS taking sets

HEMOS taking sets are intended for taking, transport and storing of small quantities of animal blood for laboratory examination and evaluation. Reg. No. with USKVBL Brno: VTP002/03-C.

HEMOS H-01

| | |
|----------------------|------------------------------------|
| Product No.: | V204851-ND |
| Name (abbreviation): | HEMOS H-01 |
| Version: | Sterile-EO |
| Group packaging: | 1 pack/50 pcs 12 pack x 50 pcs |
| Shipping packaging: | 600 pcs/carton 14.400 pcs/pallet |

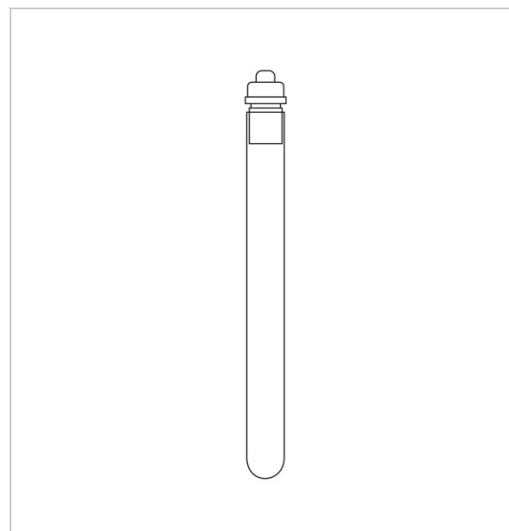

Description:

PVC taking set with cone Luer-Lock, for connection of any needle.
 The shipping package includes a permanent marker intended for marking the sample after blood collection.

Note:

for small animals

HEMOS H-02

| | |
|----------------------|------------------------------------|
| Product No.: | V204852-ND |
| Name (abbreviation): | HEMOS H-02 |
| Version: | Sterile-EO |
| Group packaging: | 1 pack/50 pcs 12 pack x 50 pcs |
| Shipping packaging: | 600 pcs/carton 14.400 pcs/pallet |



Description:

PVC taking set with integrated needle diameter 1.2 mm and cover (needle length about 27 mm).
 The shipping package includes a permanent marker intended for marking the sample after blood collection.

Note:

for farm animals (cows)

HEMOS H-03

| | |
|----------------------|------------------------------------|
| Product No.: | V204853-ND |
| Name (abbreviation): | HEMOS H-03 |
| Version: | Sterile-EO |
| Group packaging: | 1 pack/50 pcs 12 pack x 50 pcs |
| Shipping packaging: | 600 pcs/carton 14.400 pcs/pallet |



Description:

PVC taking set with integrated needle diameter 1.8 mm and cover (needle length about 70 mm).
 Part of the transport package is a permanent marker designed to mark the sample after blood collection.

Note:

for pigs

HEMOS H-04

| | |
|----------------------|------------------------------------|
| Product No.: | V204854-ND |
| Name (abbreviation): | HEMOS H-04 |
| Version: | Sterile-EO |
| Group packaging: | 1 pack/50 pcs 12 pack x 50 pcs |
| Shipping packaging: | 600 pcs/carton 14.400 pcs/pallet |



Description:

PVC taking set with tube and cover, without taking needle.
 Part of the transport package is a permanent marker designed to mark the sample after blood collection.

Note:

for collect slaughter blood

HEMOS H-05

| | |
|----------------------|------------------------------------|
| Product No.: | V204855-ND |
| Name (abbreviation): | HEMOS H-05 |
| Version: | Sterile-EO |
| Group packaging: | 1 pack/50 pcs 12 pack x 50 pcs |
| Shipping packaging: | 600 pcs/carton 14.400 pcs/pallet |

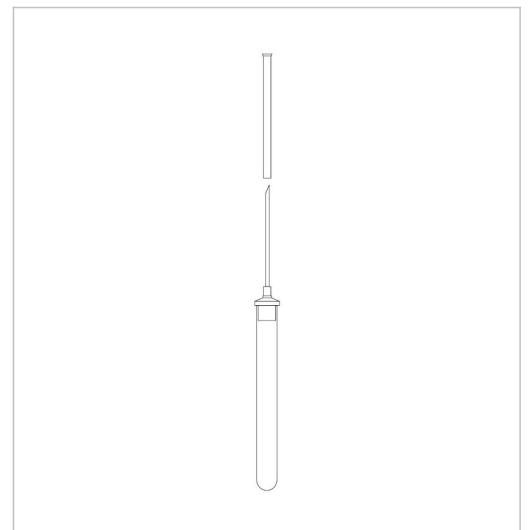

Description:

PVC taking set with integrated needle diameter 2.5 mm and cover (needle length about 72 mm).
 Part of the transport package is a permanent marker designed to mark the sample after blood collection.

Note:

for pigs

Sampling kits and other

Sampling kits and other

The sampling kits for TSE, for BSE - for sheep and goats are intended for taking of biological material - brain stem for the purpose of virological diagnosis of BSE (bovine spongiform encephalopathy) of cattle and TSE (transmissible spongiform encephalopathies - scrapia of sheep and goats. Reg. No. with USKVBL Brno: VTP001/03-C.

Sampling kit PROBANG TEST is intended for taking of biological material - oesophag, oesopharyngeal and pharyngeal mucosa of cattle for the purpose of virological diagnosis of SLAK (epizootic aphtha). Reg. No. with USKVBL Brno: VTP004/04-C.

The scrapers big, small are intended for taking of biological material - brain stem for the purpose of virological diagnosis of BSE (bovine spongiform encephalopathy) of cattle and TSE (transmissible spongiform encephalopathies -scrapia of sheep and goats). Reg. No. with USKVBL Brno: VTP003/04-C.

Blood-taking set OS-VET is used for collecting a large volume of sterile blood from animals in a suitable collection bottle. Reg.No. with USKVBL Brno: VTP/018/16-C.

BSE sampling kit

| | |
|----------------------|-----------------------------------|
| Product No.: | V204865 |
| Name (abbreviation): | BSE sampling kit |
| Version: | non sterile |
| Group packaging: | 1 pack/10 pcs 10 pack x 10 pcs |
| Shipping packaging: | 100 pcs/carton 2.800 pcs/pallet |



Description:

Sampling tool, 120 ml container with lid, self-adhesive label for identification of container, instructions for use

Note:

for cattle

TSE sampling kit - for sheep and goats

| | |
|----------------------|--|
| Product No.: | V204866 |
| Name (abbreviation): | TSE sampling kit - for sheep and goats |
| Version: | non sterile |
| Group packaging: | 1 pack/10 pcs 10 pack x 10 pcs |
| Shipping packaging: | 100 pcs/carton 2.800 pcs/pallet |



Description:

Sampling tool, 120 ml container with lid, self-adhesive label for identification of container, instructions for use

Note:

for sheep and goats

Sampling kit PROBANG TEST

| | |
|----------------------|--------------------------------|
| Product No.: | V204930 |
| Name (abbreviation): | Sampling kit PROBANG TEST |
| Version: | Sterile-EO |
| Group packaging: | |
| Shipping packaging: | 20 pcs/carton 360 pcs/pallet |



Description:

Double sided sampling spoon, 50 ml bottle with lid (2 pcs), pipette with scale up to 3 ml (2 pcs), instructions for use

Note:

for cattle

Big scraper

| | |
|----------------------|------------------------------------|
| Product No.: | V204863 |
| Name (abbreviation): | Big scraper |
| Version: | non sterile |
| Group packaging: | 1 pack/10 pcs 10 pack x 10 pcs |
| Shipping packaging: | 100 pcs/carton 12.000 pcs/pallet |

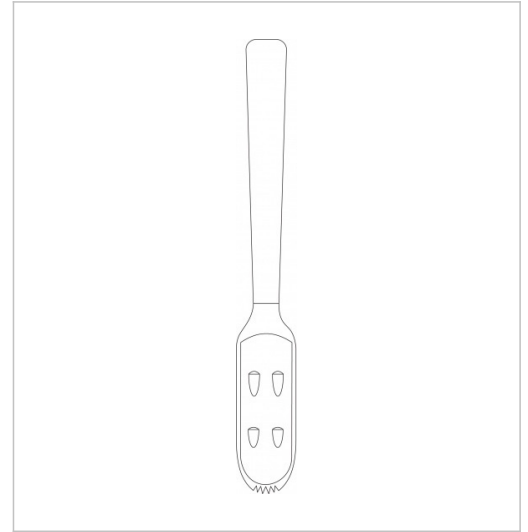

Description:
scraper, instructions for use

Note:
for cattle

Small scraper

| | |
|----------------------|------------------------------------|
| Product No.: | V204864 |
| Name (abbreviation): | Small scraper |
| Version: | non sterile |
| Group packaging: | 1 pack/10 pcs 10 pack x 10 pcs |
| Shipping packaging: | 100 pcs/carton 12.000 pcs/pallet |

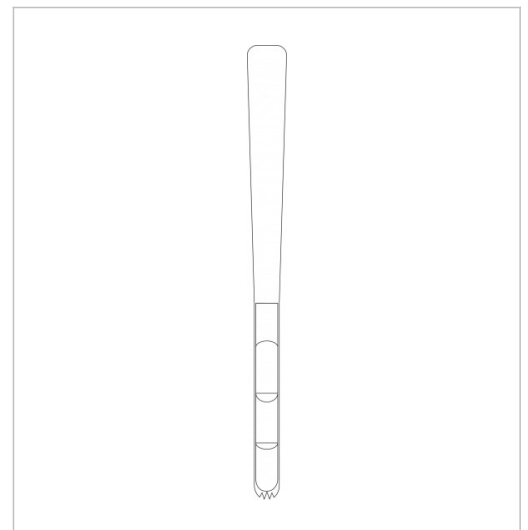

Description:
scraper, instructions for use

Note:
for sheep and goats

Blood-taking set OS VET

| | |
|----------------------|-----------------------------------|
| Product No.: | V204840 |
| Name (abbreviation): | Blood-taking set OS VET |
| Version: | Sterile- EO |
| Group packaging: | - |
| Shipping packaging: | 200 pcs/carton 4.800 pcs/pallet |

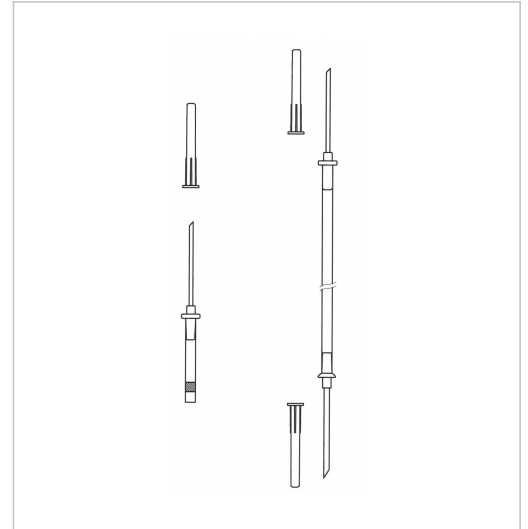

Description:

Transparent PVC tube 3.0/4.2 x 600 mm, needle 1.8 x 40 mm, needle 2.5 x 43 mm, air-release needle with antibacterial filter

Explanatory notes

| Abbreviation | Explanatory note |
|--------------|---|
| S | STERILE |
| N | NON STERILE |
| CH | CHARRIÈRE |
| ShA | HARDNESS UNIT |
| CO | CENTRAL HOLE |
| BO | SIDE HOLE |
| T PVC | HARD PVC |
| M PVC | PLASTICIZED PVC |
| PP | POLYPROPYLEN |
| PE | POLYETHYLENE |
| PS | POLYSTYRENE |
| LDPE | LOW DENSITY POLYETHYLENE |
| PMMA | POLYMETHYL METHACRYLATE |
| PET | POLYETHYLENE TEREPHTHALATE |
| HDPE | HIGH DENSITY POLYETHYLENE |
| TPE | THERMOPLASTIC ELASTOMER |
| PTFE | POLYTETRAFLUORETHYLENE |
| ABS | ACRYLONITRILE BUTADIENE STYRENE COPOLOYMER |
| PA | POLYAMIDE |
| PC | POLYCARBONATE |
| PUR | POLYURETHAN |
| TPU | THERMOPLASTIC POLYURETHANE |
| MABS | METHYL METHACRYLATE ACRYLONITRILE BUTADIENE STYRENE |
| SBC | STYRENE BUTADIENE COPOLYMER |
| NO DOP, ND | CONTAINS NO PHTALATE DIETHYLHEXL PHTALATE |
| NO PVC | CONTAINS NO POLYVINYLCHLORIDE |
| NON | no |
| R | RADIATION |
| EO | ETHYLENOXIDE |
| standardline | STANDARD - BASIC PRODUCT LINE |
| MLL | MALE LUER LOCK POSITIVE TAPER |
| FLL | FEMALE LUER LOCK NEGATIVE TAPER |
| ML | MALE LUER POSITIVE TAPER |

Contacts

GAMA GROUP a.s.

Mánesova 11/3b

České Budějovice 7

370 01 České Budějovice

Czech Republic

Business ID: 45797463, tax ID: CZ45797463

Registration in the Commercial Register: Regional Court in Č. Budějovice, sect. B, insert 1286

Phone: +420 389 000 200

E-mail: gama@gama.cz